

# PRODUCT DIMENSIONS

SIDE VIEW

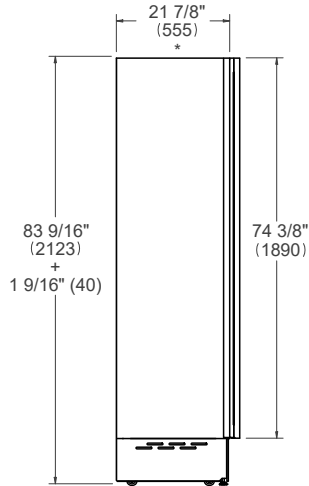

FRONT VIEW

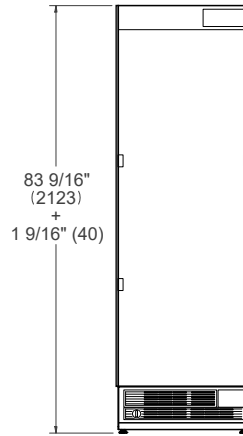

TOP VIEW

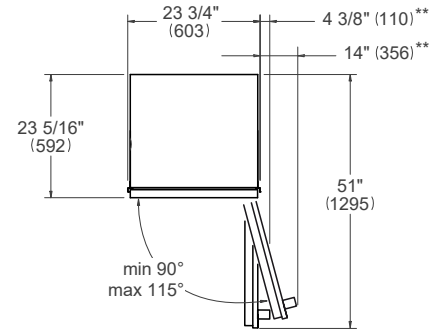

\* Depth without door  
 \*\* Maximum Overall Handle Dimension, 3/4" (19) door panel thickness

# CUTOUT DIMENSIONS

SIDE VIEW

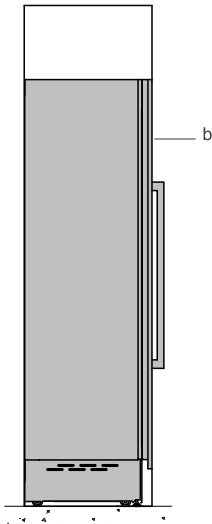

FRONT VIEW

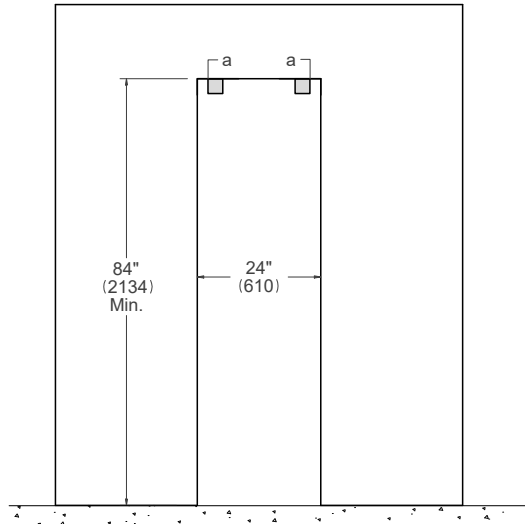

TOP VIEW

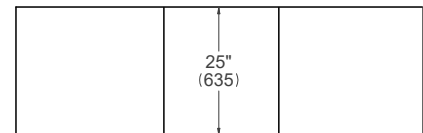

For a 25" (635) flush inset depth, max door panel thickness is 15/16" (24). Max door panel weight is 66 lbs (30 kg).

- (a) Anti-tipping brackets – included with appliance
- (b) Panel dimensions available on Door Panel Specs, Built-in Food Preservation Design Guide or Installation Manual

# ELECTRICAL & WATER CONNECTION

**E** A properly-grounded, horizontally-mounted electrical receptacle should be installed according to this drawing.

**W** To connect to the water supply system, use a 1/4" waterline with a minimum length of 60" (1500).

Connection(s) placement within the opening may require additional cabinet depth.

TOP VIEW

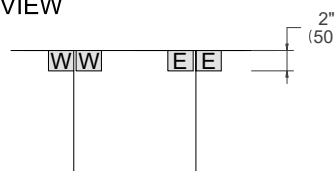

FRONT VIEW

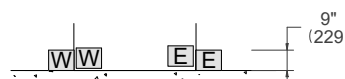

# INSTALLATION REQUIREMENTS

If the appliance(s) is not connected through the side profile trims to secured cabinetry anti-tip brackets must be installed.