



EN

INSTALLATION MANUAL
USER AND MAINTENANCE MANUAL
BUILT-IN COFFEE MACHINE

FROM THE DESK OF OUR PRESIDENT

Dear new owner of a Bertazzoni appliance,

I want to thank you for choosing one of our beautiful products for your home.

My family started manufacturing kitchen appliances in Italy in 1882, building a reputation for quality of engineering and passion for good food.

Today, our products stand out because of their unique blend of authentic Italian design and superior appliance technology. It is our mission to make products that function perfectly and bring joy to their owners.

By making beautiful products we respond to our customers' flair for good design. By making them versatile and easy-to-use, cooking with Bertazzoni becomes a real pleasure.

This manual will help you learn to use and care for your Bertazzoni appliance in the safest and most effective way, so that it can give you the highest satisfaction for years to come.

Enjoy!

Paolo Bertazzoni

President

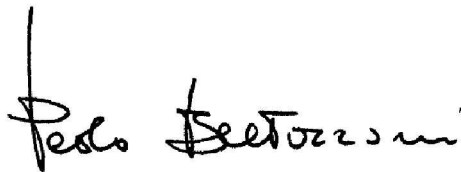
A handwritten signature in black ink that reads "Paolo Bertazzoni". The signature is written in a cursive style with a vertical line above the first letter 'P'.

CONTENTS

INTRODUCTION AND WARNINGS	5
READING THE MANUAL	5
APPLIANCE IDENTIFICATION	5
SYMBOL USED	5
WARNINGS FOR THE USER	6
WARNINGS FOR THE INSTALLATION	8
INSTALLATION MANUAL	9
BUILT-IN INSTALLATION	9
USING THE APPLIANCE	12
DESCRIPTION OF THE APPLIANCE	12
DESCRIPTION OF HOMEPAGE	13
DESCRIPTION OF THE ACCESSORIES	13
DESCRIPTION OF THE MILK CONTAINER	14
PRELIMINARY OPERATIONS	14
TECHNICAL DATA	14
SETTING UP THE APPLIANCE	14
TURNING THE APPLIANCE ON	16
TURNING THE APPLIANCE OFF	17
MENU SETTING	17
MAKING COFFEE	21
MAKING MILK-BASED HOT DRINKS	27
CUSTOMISING BEVERAGES	35
MEMORISING YOUR PERSONAL PROFILE	35
CLEANING	36
CLEANING AND MAINTENANCE OF MATERIALS IN CONTACT WITH FOOD	36
CLEANING THE MACHINE	36
CLEANING THE APPLIANCE INTERNAL CIRCUIT	36
CLEANING THE COFFEE GROUNDS CONTAINER	37
CLEANING THE DRIP TRAY	38
CLEANING THE INSIDE OF THE COFFEE MACHINE	38
CLEANING THE WATER TANK	38
CLEANING THE COFFEE SPOUTS	39
CLEANING THE PRE-GROUND COFFEE FUNNEL	39
CLEANING THE INFUSER	39
CLEANING THE MILK CONTAINER (D)	41
CLEANING THE HOT WATER/STEAM CONNECTION NOZZLE	41
DESCALING	42
PROGRAMMING WATER HARDNESS	44
PROGRAMMING WATER HARDNESS	44
MEASURING WATER HARDNESS	44
SETTING WATER HARDNESS	44
WATER SOFTENER FILTER	45
INSTALLING THE FILTER	45
REPLACING THE FILTER	46
REMOVING THE FILTER	46
DISPLAYED MESSAGES	47
TROUBLESHOOTING	52
TROUBLESHOOTING AND REPAIRS	53
WARRANTY AND SERVICE	54

INTRODUCTION AND WARNINGS

READING THE MANUAL

These instructions are suitable for different types of appliances, so they may contain descriptions of functions which your appliance may not contain or support.

The images and illustrations in this document refer to various models and may differ slightly from the product purchased.

The manufacturer does not accept any responsibility for personal injury or damage to property arising from incorrect installation or misuse of the appliance.

The manufacturer reserves the right to modify the various models as required to comply with the technical regulations in force.

In the event of complaints, please contact the customer service.

APPLIANCE IDENTIFICATION

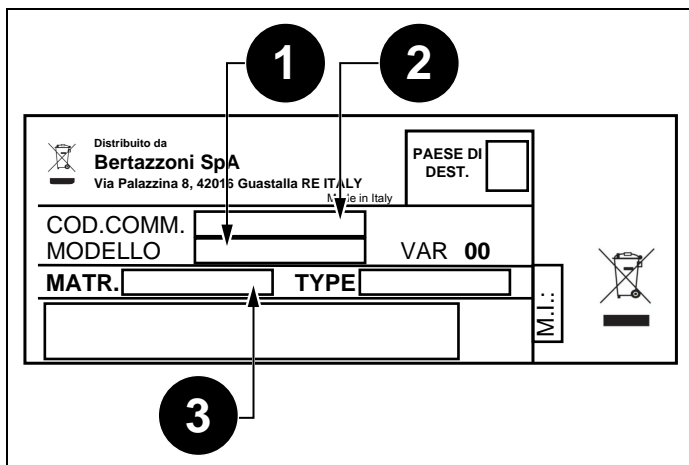

Fig. 1

The dataplate contains the following information:

- 1 Model
- 2 Sales Code
- 3 Serial Number



NOTE

You are advised to make a note of the appliance's data and serial numbers so they are immediately available if required.



NOTE

State the information provided on the dataplate to improve the efficiency of the after-sales and parts services.

SYMBOL USED

Important warnings are identified by these symbols. Failure to observe the Instructions for Use could result in electric shock, serious injury, burns, fire or damage to the appliance



DANGER

Failure to observe the warning may result in life threatening injury or death.



CAUTION

Failure to observe the warning could result in injury or damage to the appliance.



IMPORTANT

This symbol identifies important advice or information for the user.



NOTE

This symbol identifies important advice or information for the user.

INTRODUCTION AND WARNINGS

WARNINGS FOR THE USER

Read these Instructions for Use carefully before using the appliance.

- Keep these Instructions for Use carefully.
- Failure to follow these Instructions for Use may result in injury or damage to the appliance. The manufacturer is not liable for damage deriving from failure to respect these Instructions for Use.



NOTE

The appliance is equipped with a fan. It activates when necessary.

FUNDAMENTAL SAFETY WARNINGS

The appliance is not intended for use by persons (including children) with reduced physical, sensory or mental capabilities, or lack of experience and knowledge, unless they have been given supervision or instruction concerning use of the appliance by a person responsible for their safety.

Children should be supervised to ensure that they do not play with the appliance.

Designated use: this appliance is designed and made to prepare coffee and milk based beverages and hot water. Any other use is considered improper and thus dangerous.

The manufacturer is not liable for damage deriving from improper use of the appliance.

The surface of the heating element remains hot after use and the outside of the appliance may retain the heat for several minutes depending on use.



CAUTION

This is an household appliance only. It is not intended to be used in: staff kitchen areas in shops, offices and other working environments; farm houses; by clients in hotels, motels and other residential type environments; bed and breakfast type environments.



CAUTION

If the plug or power cable is damaged, it must be replaced by customer services only to avoid all risk.



CAUTION

Appliances with removable cord: avoid splashes of water on the power cord connector or socket at the back of the appliance.



WARNING

Models with glass surfaces: do not use the appliance if the surface is cracked.

This appliance can be used by children aged from 8 years and above if they have been given supervision or instruction concerning use of the appliance in a safe way and if they understand the hazard involved. Cleaning and user maintenance shall not be made by children unless they are older than 8 and supervised. Keep the appliance and its cord out of the reach of children aged less than 8 years.

Appliances can be used by persons with reduced physical, sensory or mental capabilities or lack of experience and knowledge if they have been given supervision or instruction concerning use of the appliance in a safe way and understand the hazards involved.

Children shall not play with the appliance. When not in use and before cleaning, always unplug the appliance.



DANGER

Surfaces marked with this symbol become hot during use (the symbol is present in certain models only).

INTRODUCTION AND WARNINGS



DANGER

This is an electrical appliance, it is therefore important to respect the following safety warnings:

- Never touch the appliance with damp hands.
- Never touch the plug with damp hands.
- Make sure the socket used is freely accessible at all times, enabling the appliance to be unplugged when necessary.
- Unplug directly from the plug only. Never pull the power cable as you could damage it.
- To disconnect the appliance completely, place the main switch (A23) on the side of the appliance in the 0 position.
- If the appliance is faulty, do not attempt to repair. Turn it off using the main switch (A23), unplug from the mains socket and contact Customer Services.



DANGER

This appliance produces hot water and steam may form while it is in operation.

Avoid contact with splashes of water or hot steam. Use knobs and handles.



WARNING

Keep all packaging (plastic bags, polystyrene foam) away from children.



WARNING

CHOKING HAZARD. The appliance might contain small parts. Some of those small parts might be required to get disassembled during cleaning and maintenance operations. Handle with care and keep small parts out of reach of children.



CAUTION

Do not hold on to the coffee machine when it is out of the cabinet.

Do not rest recipients containing liquids or inflammable or corrosive materials on top of the appliance. Place the accessories required to make the coffee (the measure for example) in the special holder. Do not rest large objects which could obstruct movement or unstable objects on the appliance.

Do not allow children and animals to stop or linger near the appliance when it is pulled out of the cabinet.

Do not leave the machine pulled out of the cabinet when it is being used.

Do not leave the machine pulled out of the cabinet when it is not needed.

Install the machine according to the instructions in the handbook to guarantee there are no spills when it is pulled out from the cabinet.



CAUTION

Do not use the appliance when extracted.

Make sure the appliance is inactive before extracting it. The only exception is adjusting the coffee mill which must be done with the machine extracted (see section *Adjusting the coffee mill*).



CAUTION

Never turn off the machine during descaling.



NOTE

Use original or manufacturer recommended accessories and spare parts only.

DESIGNATED USE

This appliance is designed and made to prepare coffee and heat drinks. All other use is considered improper.

This appliance is not suitable for commercial use.

The manufacturer is not liable for damage deriving from improper use of the appliance.

This appliance can be installed over a built-in oven if the latter is fitted with a cooling fan at the rear (maximum microwave power: 3 kW).

INTRODUCTION AND WARNINGS

WARNINGS FOR THE INSTALLATION



WARNING

Installation must be performed by a qualified professional in compliance with legislation in force in the country of installation (see section “Built-in installation”).



WARNING

The packing elements (plastic bags, polystyrene foam, etc.) should be kept out of reach of children.



WARNING

Never install the appliance in rooms where the temperature may drop to 0°C or lower.



WARNING

Customise the water hardness as soon as possible following the instructions in the section *Setting water hardness*.

CONNECTING THE APPLIANCE



DANGER

Check that the mains power supply voltage corresponds to the value indicated on the rating plate on the bottom of the appliance.

Connect the appliance to an efficiently earthed and correctly installed socket with a minimum current rating of 10 A only.

If the power socket does not match the plug on the appliance, have the socket replaced with a suitable type by a qualified professional. To comply with safety directives, an omnipolar switch with a minimum contact distance of 3 mm must be installed.

Do not use multiple sockets or extensions.



CAUTION

Safety cutout devices must be included in the mains power supply in compliance with the installation regulations in the country concerned.

NOTE



This appliance conforms to EC Regulation 1935/2004 on materials and articles intended to come into contact with food.



The appliance must not be disposed of with household waste, but taken to an authorised waste separation and recycling centre.

INSTALLATION MANUAL

BUILT-IN INSTALLATION

Verify the minimum measurements required for correct installation of the appliance. The coffee machine must be installed in a column and the column must be firmly fixed to the wall with commercially available brackets.



CAUTION

All installation or maintenance operations must be performed with the appliance disconnected from the mains electricity supply.

- Kitchen furniture in direct contact with the appliance must be heat resistant (65°C min).
- To guarantee correct ventilation, leave a gap at the bottom of the cabinet (see measurements in Fig. 2 and Fig. 3).

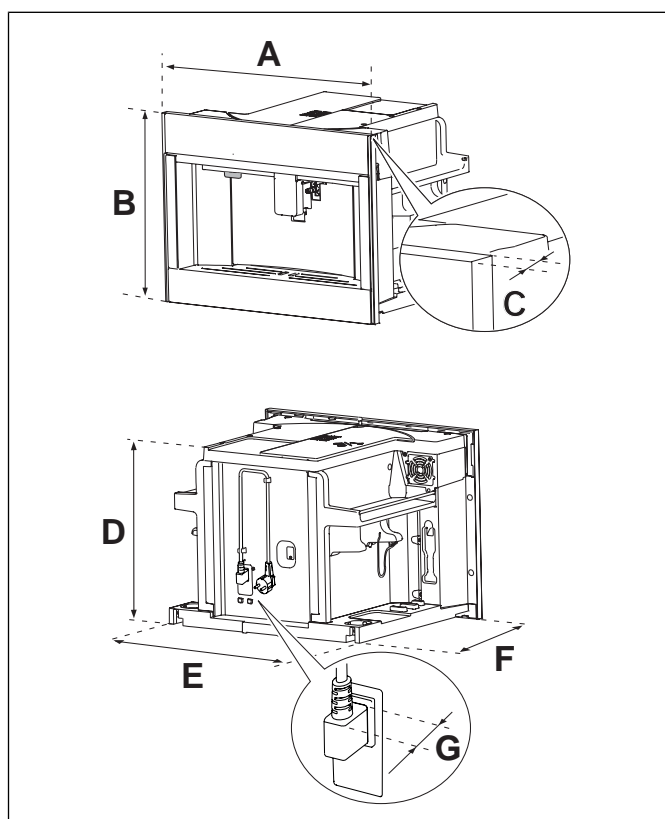

Fig. 2

- | | |
|---------------|-----------|
| A. 594–597 mm | D. 428 mm |
| B. 450–455 mm | E. 545 mm |
| C. 19–22 mm | F. 450 mm |
| | G. 30 mm |

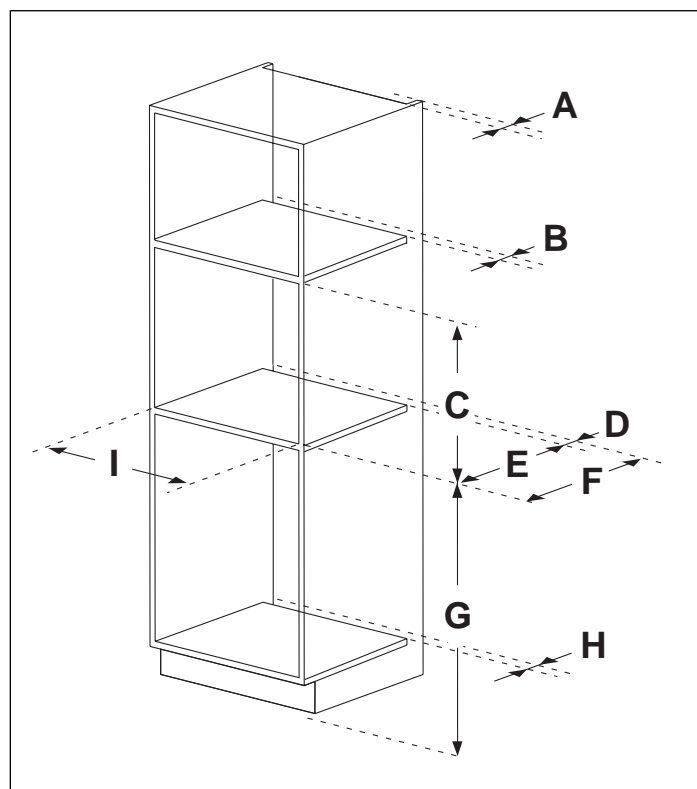

Fig. 3

- | | |
|---------------|----------------|
| A. 45 mm | E. 500 mm |
| B. 45 mm | F. Min. 545 mm |
| C. 450 + 2 mm | G. Min. 850 mm |
| D. 45 mm | H. 45 mm |
| | I. 560 + 8 mm |

INSTALLATION MANUAL

- Position the rails on the sides of the cabinet as shown in the Fig. 4 . Fix with the screws provided, then extract them completely.

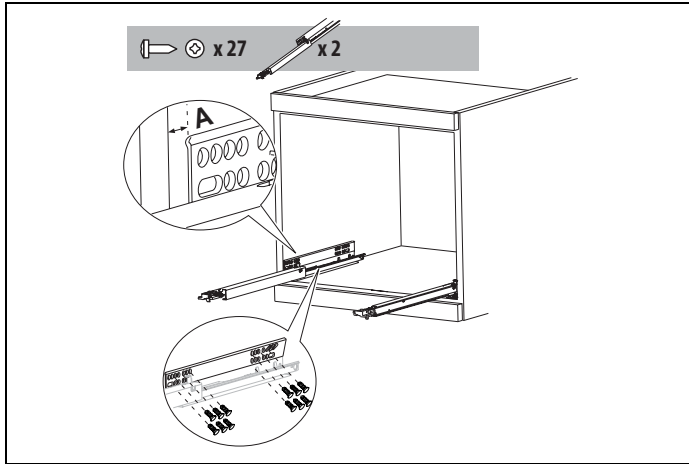

Fig. 4

A. 2 mm

If the coffee machine is installed over a warmer drawer, use the top surface of this as a reference to position the rails (Fig. 5).

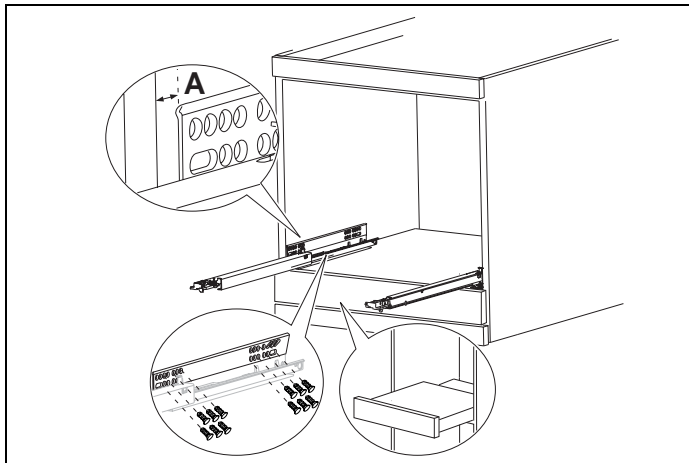

Fig. 5

A. 2 mm

- Fix the power cable with the clip (Fig. 6). The power cable must be long enough to allow the appliance to be extracted from the cabinet to fill the coffee bean container.

The appliance must be earthed in compliance with legislation.

Electrical connections must be performed by a qualified electrician following the instructions.

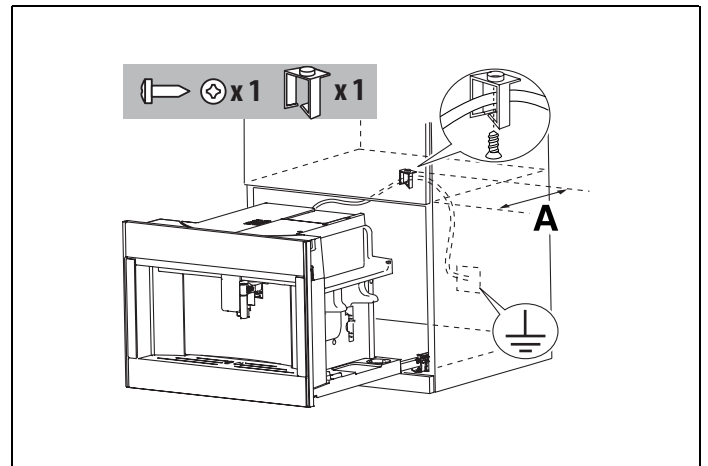

Fig. 6

A. Approx. 350 mm

- Position the appliance on the rails, (only after these have been assembled on the cabinet. This is to avoid placing the machine on a surface not suited to such use) making sure the pins are correctly inserted in the housings, then fix it with the screws supplied (Fig. 7). If the height of the appliance requires adjusting, use the spacer disks provided.

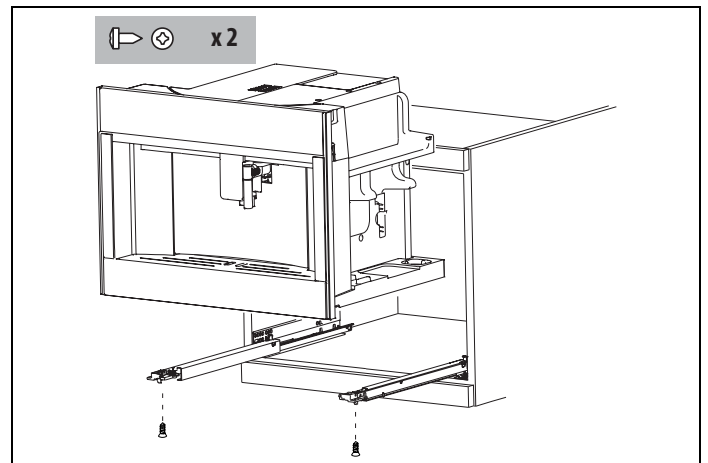

Fig. 7

INSTALLATION MANUAL

- If necessary, correct alignment of the appliance by positioning the spacers supplied under or at the sides of the support (Fig. 8 , Fig. 9).

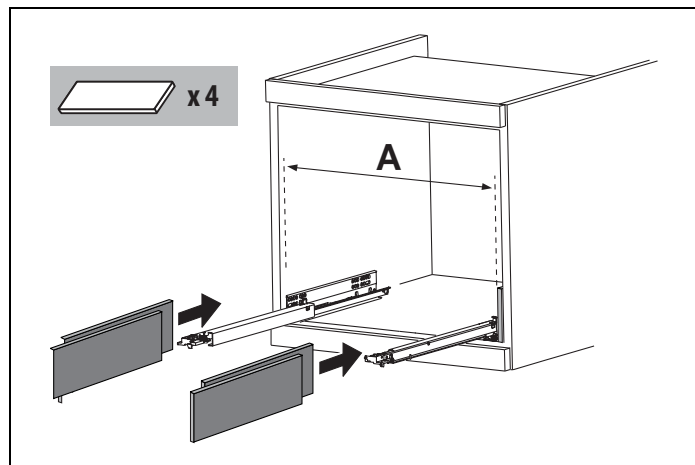

Fig. 8

A. 560 + 1 mm

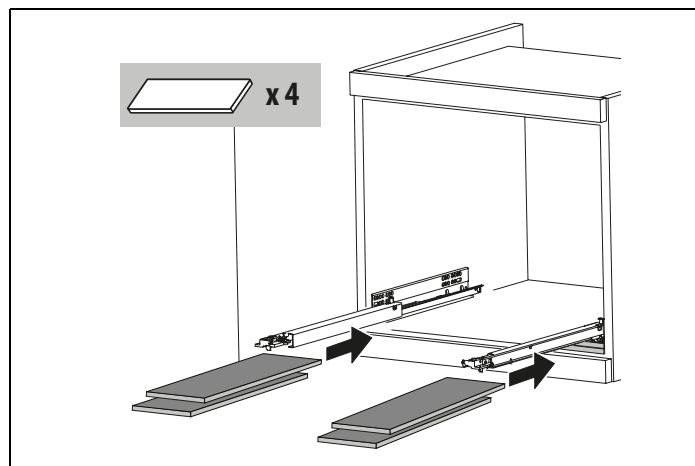

Fig. 9

- To lift the appliance in the front (max 2 mm), turn the latch as shown in Fig. 10 .

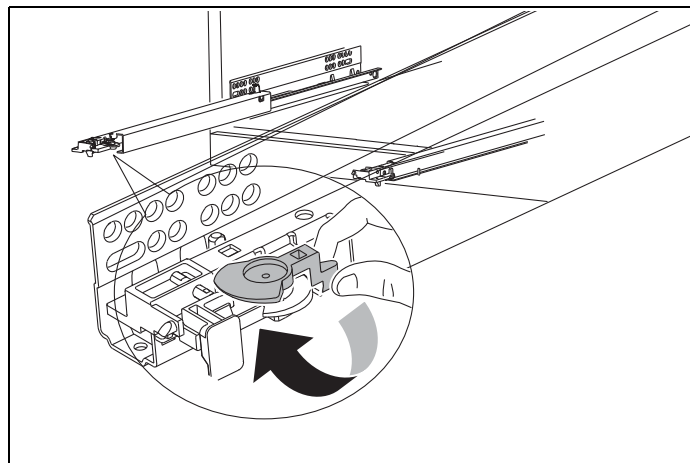

Fig. 10

- The rails fixing panel must have a thickness suited to the fixing screws supplied standard.
- The panel material must be suited to the machine weight of approximately 25 kg (55 lb).

USING THE APPLIANCE

DESCRIPTION OF THE APPLIANCE



NOTE

The letters in brackets refer to the key in the Description of the appliance.

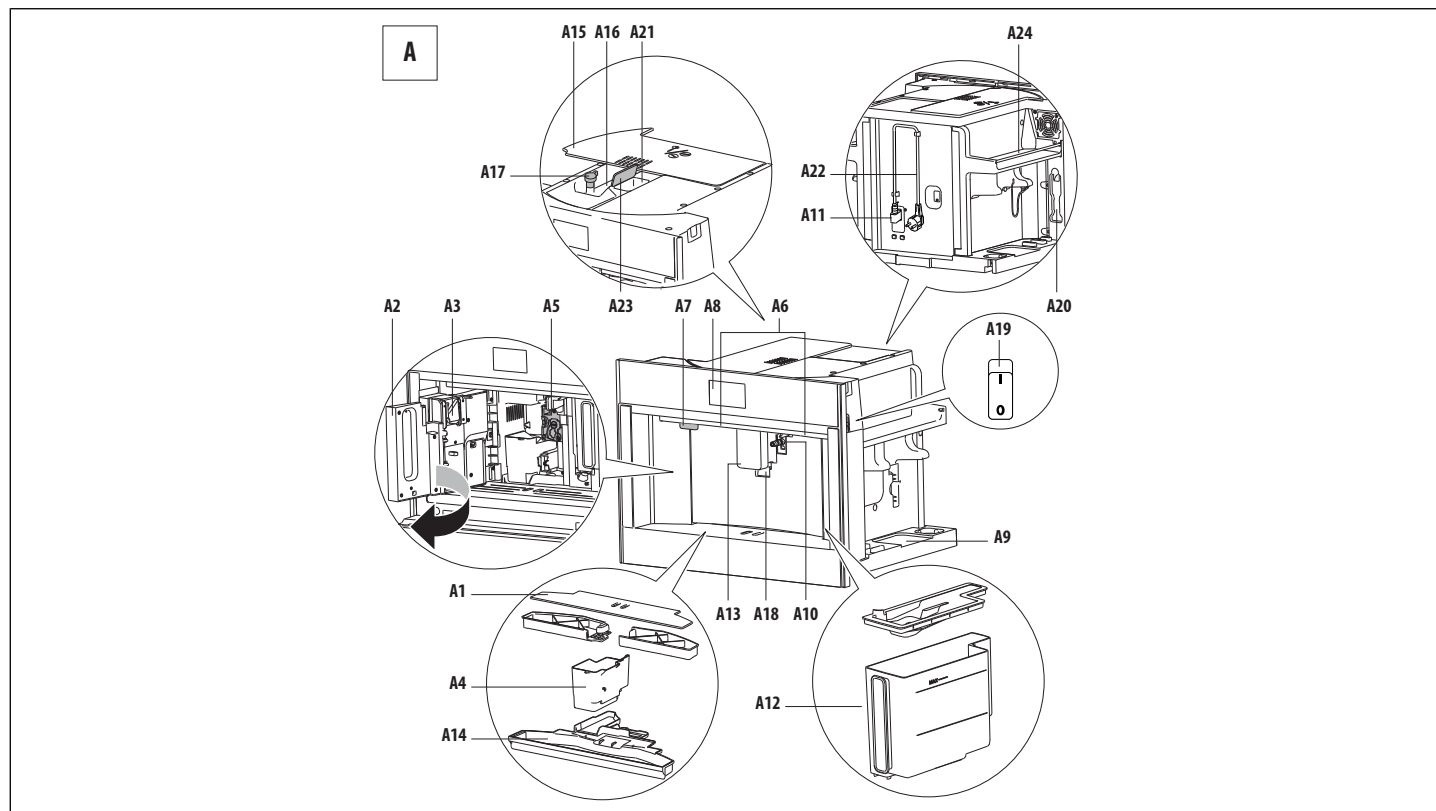

Fig. 11

- **A1**—Cup holder tray
- **A2**—Service door
- **A3**—Coffee guide
- **A4**—Coffee grounds container
- **A5**—Infuser
- **A6**—Lighting to illuminate interior compartment
- **A7**—On/stand-by button
- **A8**—Control panel
- **A9**—Storage tray
- **A10**—Hot water/steam connection nozzle
- **A11**—IEC connector
- **A12**—Water tank
- **A13**—Coffee spouts (adjustable height)
- **A14**—Drip tray
- **A15**—Beans container lid
- **A16**—Beans container
- **A17**—Grinding adjustment dial
- **A18**—Lights to illuminate cup
- **A19**—Main ON/OFF switch
- **A20**—Measure holder
- **A21**—Ground coffee funnel
- **A22**—Power cord
- **A23**—Pre-ground door
- **A24**—Cup warming ledge

USING THE APPLIANCE

DESCRIPTION OF HOMEPAGE

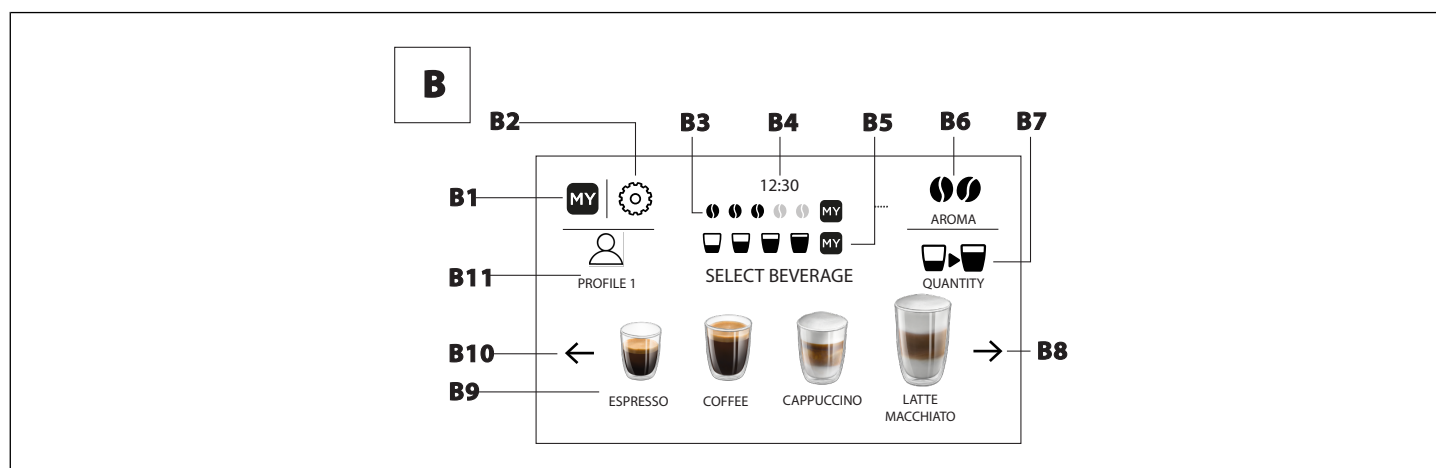

Fig. 12

- **B1**—Menu to customise beverages settings
- **B2**—Appliance settings menu
- **B3**—Selected aroma
- **B4**—Clock
- **B5**—Selected quantity
- **B6**—Aroma selection
- **B7**—Quantity selection
- **B8**—Scroll arrow
- **B9**—Selectable drinks (press on the scrolling arrow to see all the drinks)
- **B10**—Scroll arrow
- **B11**—Customisable profiles (see *Memorising your personal profile*)

DESCRIPTION OF THE ACCESSORIES

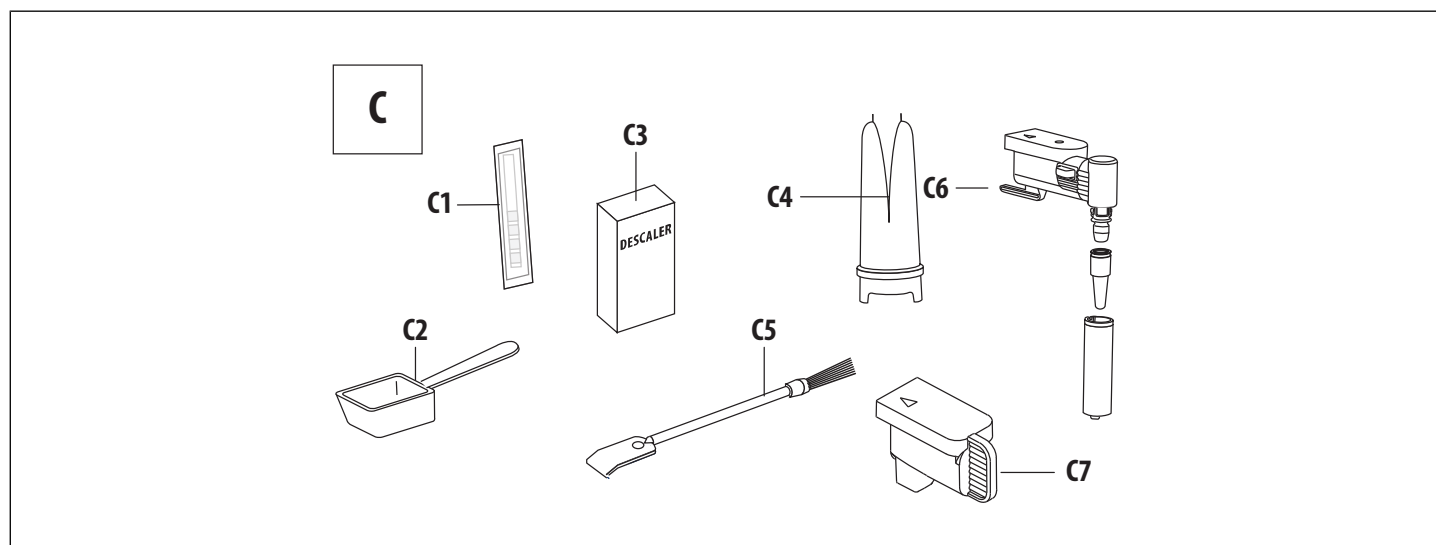

Fig. 13

- **C1**—"Total Hardness Test" indicator paper
- **C2**—Ground coffee measure
- **C3**—De-scaler
- **C4**—Water softener filter (certain models only)
- **C5**—Cleaning brush
- **C6**—Hot water/steam spout
- **C7**—Connection nozzle cover

USING THE APPLIANCE

DESCRIPTION OF THE MILK CONTAINER

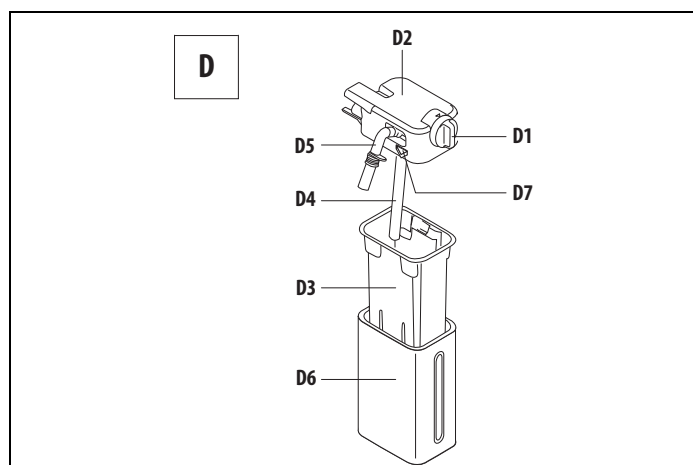

Fig. 14

- **D1**—Froth adjustment and “CLEAN” function dial
- **D2**—Lid with milk frother
- **D3**—Milk container
- **D4**—Milk intake tube
- **D5**—Adjustable frothed milk spout
- **D6**—Thermal casing
- **D7**—Lid release buttons

PRELIMINARY OPERATIONS

After removing the packaging, make sure the product is complete and undamaged and that all accessories are present. Do not use the appliance if it is visibly damaged. Contact customer services Technical Assistance.

TECHNICAL DATA

Voltage:	220-240 V~ 50/60 Hz max. 10 A
Absorbed power:	1350 W
Pressure:	15 bar
Water tank capacity:	2.5 litres
Size (L x H x D):	597 x 450 x 470 mm
Net weight:	20 kg (44.1 lb)

SETTING UP THE APPLIANCE



NOTE

Coffee has been used to factory test the appliance and it is therefore completely normal to find traces of coffee in the mill. The machine is, however, guaranteed to be new.

- 1) Connect the appliance to the mains electricity supply (Fig. 15) and make sure the main switch (**A19**) on the side of the appliance is pressed down (Fig. 16);

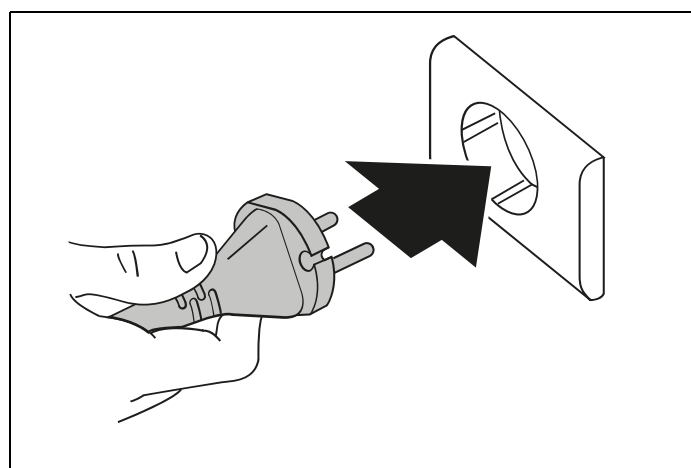

Fig. 15

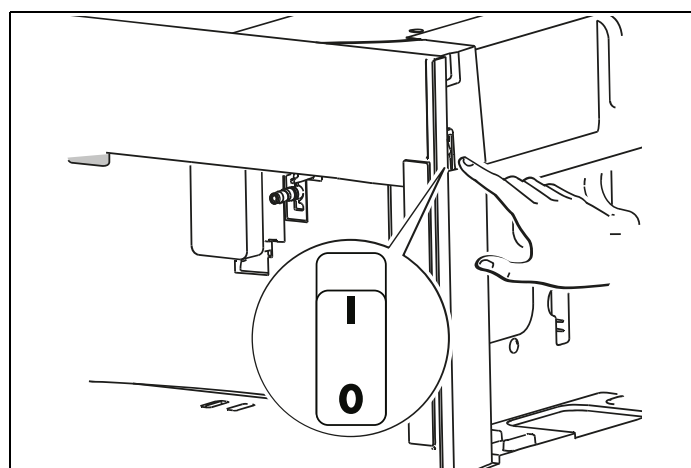

Fig. 16

- 2) **SELECT LANGUAGE (setting language):** press ← (**B10**) or → (**B8**) until the flag corresponding to the required language appears on the display, then press the flag;

USING THE APPLIANCE

- 3) **FILL WATER TANK WITH FRESH WATER:** remove the water tank (A12) (Fig. 17), open the lid (Fig. 18), fill to the MAX line (marked on the inside of the tank) with fresh water (Fig. 19); close the lid and put the tank back into the appliance (Fig. 20);

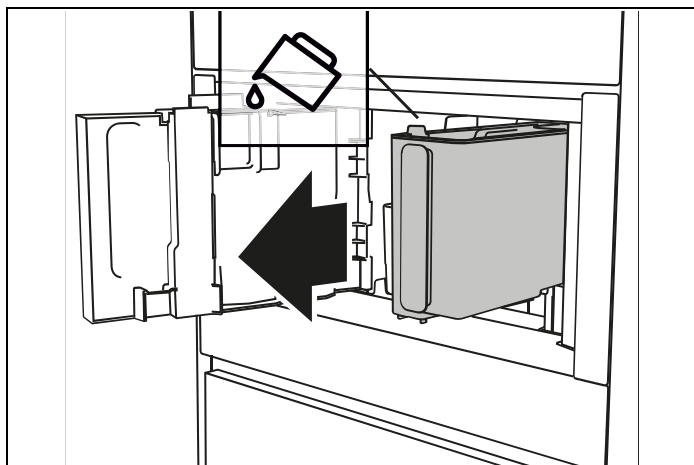

Fig. 17

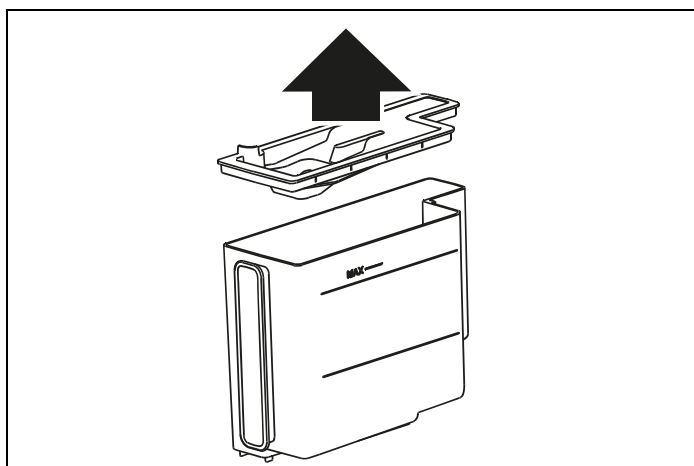

Fig. 18

To proceed follow the instructions indicated on the appliance display:

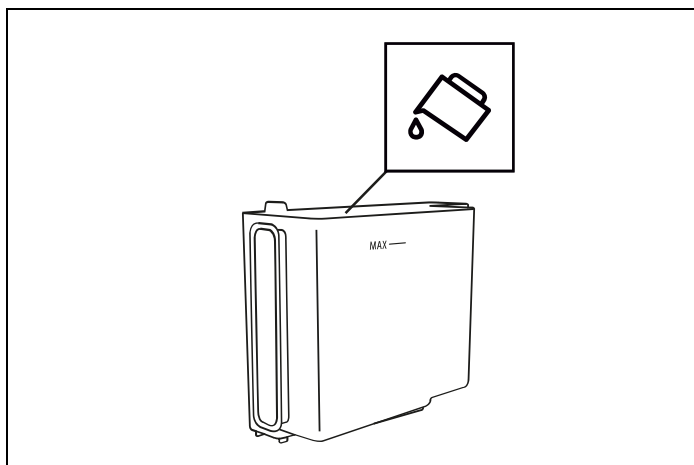

Fig. 19

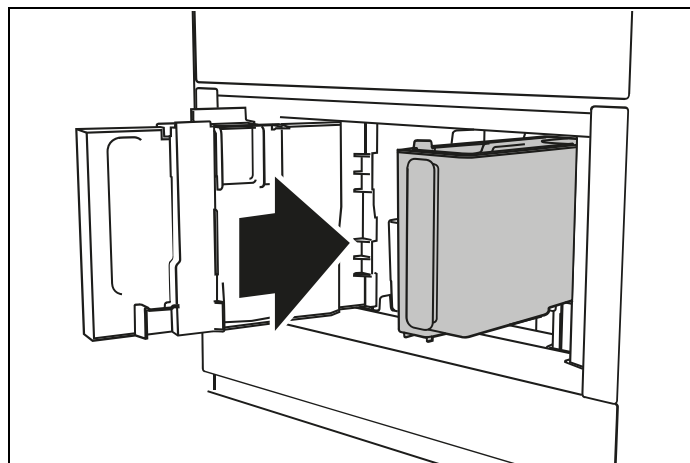

Fig. 20

- 4) **INSERT WATER OUTLET:** Check that the hot water/ steam spout (C6) is inserted on the connection nozzle (A10) (Fig. 21) and place a container with a minimum capacity of 100 ml underneath (Fig. 22);

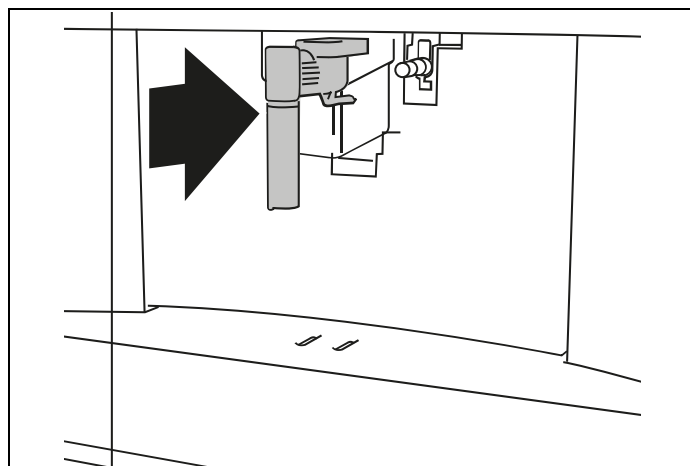

Fig. 21

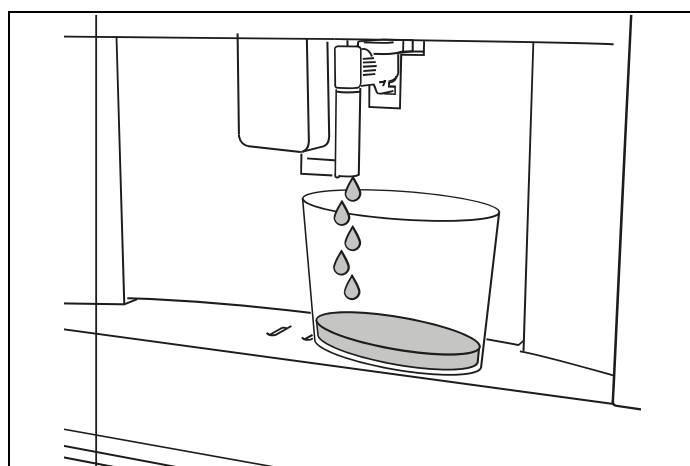

Fig. 22

USING THE APPLIANCE

5) **Water circuit empty** Press **OK** to start filling process is shown on the display;

6) Press **√ OK** to confirm: the appliance delivers water from the spout (Fig. 22) then goes off automatically.

The coffee machine is now ready for normal use.



NOTE

- The first time the appliance is used, it needs to make 4-5 cappuccinos before it starts to give satisfactory results.
- On first use the water circuit is empty, the machine could therefore be very noisy: the noise will lessen as the circuit fills up.
- When making the first 5-6 cappuccinos, it is normal to hear the noise of boiling water: after this the noise will lessen.
- To improve the performance of the appliance, we recommend installing a water softener filter (**C4**) as described in section *WATER SOFTENER FILTER* . If your model is not equipped with a filter, it is possible to request one from Authorised Customer Service Centres.

TURNING THE APPLIANCE ON



NOTE

Before turning the appliance on, make sure the main switch (**A23**) is pressed (Fig. 16). Each time the appliance is turned on, it performs an automatic preheat and rinse cycle which cannot be interrupted. The appliance is ready for use only after completion of this cycle.



DANGER

During rinsing, a little hot water comes out of the coffee spouts (**A13**) and is collected in the drip tray (**A14**) underneath. Avoid contact with splashes of water.

- To switch the appliance on, press the button  (**A7-Fig. 23**): message **Heating up Please wait**, is shown on the display.
- When heating is complete, the message changes to: **Rinsing Hot water running**; As well as heating the boiler, the appliance also continues to allow hot water to run in the internal pipework as they also heat up.

The appliance is at the desired temperature when the main screen, homepage, appears.

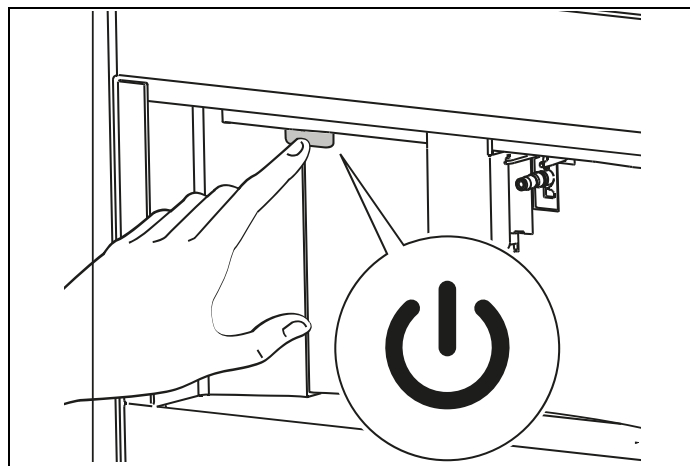

Fig. 23

USING THE APPLIANCE

TURNING THE APPLIANCE OFF

Every time the appliance is turned off, it automatically carries out a rinse if it has made a coffee.



DANGER

During rinsing, a little hot water flows from the coffee spouts **(A13)**. Avoid contact with splashes of water.

- To turn the appliance off, press the button  **(A7-Fig. 23)**.
- The message **Turning off Please wait** is shown on the display: if needed the appliance performs a rinse cycle and then goes off (standby).



NOTE

If the appliance is not used for long periods, disconnect from the electricity supply as follows:

- 1) First turn the appliance off by pressing the button  **(A7-Fig. 23)**;
- 2) Release the main switch **(A23)** situated on the side of the appliance (Fig. 16).



CAUTION







Never press the main switch while the appliance is on.

MENU SETTING

RINSING

Use this function to supply hot water from the coffee spouts **(A13)** to clean and heat the appliance's internal circuit. Place a container with a minimum capacity of 100 ml under the coffee and hot water spouts (Fig. 23).

To enable the function, proceed as follows:

- 1) Press  **(B2)** to enter the menu;
- 2) Press  **(B10)** or  **(B8)** until the display shows **(B)**   **Rinsing**;
- 3) Press  to start rinsing.
- 4) After a few seconds, hot water comes out of the coffee spout which cleans and heats the internal circuit of the appliance: the following message is shown on the display **Rinsing Hot water running** as well as a progress bar which fills up as the preparation progresses;
- 5) To stop the rinsing cycle, press  **STOP** or wait for rinsing to stop automatically.



DANGER

Do not leave the appliance unattended while hot water is being delivered.













NOTE

- If the appliance is not used for more than 3-4 days, when switched on again, we strongly recommend doing 2/3 rinses before use;
- After rinsing, it is normal that there is some water in the grounds container **(A4)**.

USING THE APPLIANCE

BEVERAGES SETTINGS

In this section, you can consult your customised settings and, if you wish, reset the default values for each beverage.

- 1) Press  (B2) to enter the menu;
- 2) Press  (B10) or  (B8) until **Drink settings**  appears on the display (B);
- 3) Press : The values for the first beverage appear on the display;
- 4) The reference user profile is highlighted on the display. The values are shown on the vertical bars: the manufacturer default value is indicated by the symbol  while the current set value is highlighted by the filled part of the vertical bar;
- 5) To go back to the settings menu, press  ESC.
- 6) To scroll and display the beverages, press  NEXT;
- 7) To return to the default manufacturer values for the beverage shown on the display, press **RESET**; 
- 8) **Confirm reset?**: to confirm, press  OK (to cancel, press  ESC);

The beverage has been reset to the default values. Continue with the other beverages, or go back to the settings menu.











NOTE



- To change the beverages for another profile, go back to the homepage, select the required profile (B11) and repeat the procedure.
- To reset all the beverages in the profile to the default values, see paragraph "Default values".

SET TIME

To adjust the time on the display (B), proceed as follows:

- 1) Press  (B2) to enter the menu;
- 2) Press  (B10) or  (B8) until the display (B) shows **SET TIME** ;
- 3) Press : The time setting panel appears on the screen;
- 4) Press  or  corresponding to the hours and minutes until the current time is displayed;
- 5) To confirm, press  OK (to cancel, press  ESC), then press  ESC to go back to the homepage.

The time is now set.

AUTO-START













The auto-start time can be set in order to have the appliance ready at a certain time (for example in the morning) so that it can immediately make coffee.

NOTE



To enable this function, the time must already be set correctly, see paragraph *Set time*.

To enable auto-start, proceed as follows:

- 1) Press  (B2) to enter the menu;
- 2) Press  (B10) or  (B8) until the display (B) shows **AUTO-START** ;
- 3) Select the function by pressing : The time setting panel appears on the screen;
- 4) Press  or  corresponding to the hours and minutes until the required auto-start time is displayed;
- 5) Press  **OFF** or  **ON** to enable or disable auto-start.
- 6) To confirm, press  OK (to cancel and go back to the settings menu press  ESC), then press  ESC to go back to the home page.

NOTE



The auto-start time is now set and the corresponding symbol is displayed next to the time to indicate that the function has been enabled.

NOTE





When the appliance is turned off using the main switch (A21), the auto-start setting if enabled, is lost.

USING THE APPLIANCE

AUTO-OFF (STANDBY)



Auto-off can be set so that the appliance goes off after 15 or 30 minutes, or 1, 2 or 3 hours of no use.

To programme Auto-off, proceed as follows:

- 1) Press  (B2) to enter the menu;
- 2) Press \leftarrow (B10) or \rightarrow (B8) until the display (B)  shows **Auto-off**, together with the current selection (15 or 30 minutes, or 1, 2 or 3 hours);
- 3) Press  on the display to select the required value;
- 4) Press \rightarrow ESC to go back to the home page. Auto-off is now programmed.

CUP WARMER



To warm the cups before making coffee, it is possible to activate the cup warmer (A24) and put it above the cups.

- 1) Press  (B2) to enter the menu;
- 2) Press \leftarrow (B10) or \rightarrow (B8) until the display (B) shows  **Cup warmer**;
- 3) Press  to activate- **ON** or de-activate - **OFF** the cup warmer.
- 4) Press \rightarrow ESC to go back to the home page.

ENERGY SAVING



Use this function to enable or disable energy saving mode. When enabled, the function guarantees reduced energy consumption in compliance with European regulations. When it is disabled, warming time is reduced.

To disable or enable "Energy Saving", proceed as follows:

- 1) Press  (B2) to enter the menu;
- 2) Press \leftarrow (B10) or \rightarrow (B8) until  **Energy saving** appears on the display (B);
- 3) Press  to enable- **ON** or disable- **OFF** energy saving.
- 4) Press \rightarrow ESC to go back to the home page.



COFFEE TEMPERATURE

To modify the temperature of the water supplied to make the coffee, proceed as follows:

- 1) Press  (B2) to enter the menu;
- 2) Press \leftarrow (B10) or \rightarrow (B8) until the display (B)  shows **Coffee temperature** together with the current selection (**Low**, **Medium**, **High** or **Max**);
- 3) Press  to select the required temperature;
- 4) Press \rightarrow ESC to go back to the home page.

SELECTING THE LANGUAGE



To modify the language of the display (B), proceed as follows:

- 1) Press  (B2) to enter the menu;
- 2) Press \leftarrow (B10) or \rightarrow (B8) until the display shows  **Set language**;
- 3) Press : press \leftarrow or \rightarrow until the flag corresponding to the required language is shown and then select it;
- 4) Press \rightarrow ESC 2 times to go back to the home page.

SOUND NOTIFICATION

This paragraph explain how enable or disable the beep emitted by the machine each time an icon is pressed or an accessory is inserted/removed.

To disable or enable the beep, proceed as follows:





- 1) Press  (B2) to enter the menu;
- 2) Press \leftarrow (B10) or \rightarrow (B8) until the display (B) shows  **Beep**;
- 3) Press  to enable- **ON** or disable- **OFF** the sound notification;
- 4) Press \rightarrow ESC to go back to the home page.

USING THE APPLIANCE

LIGHTS





This function enables or disables the lights **(A6)**. The cup lights **(A18)** come on each time coffee beverages are produced, hot milk is made and during each rinse cycle and turn off after a few seconds.

To disable or enable this function, proceed as follows:

- 1) Press  **(B2)** to enter the menu;
- 2) Press **← (B10)** or **→ (B8)** until the display **(B)** shows  **Cup lighting**;
- 3) Press  to enable-or disable  -the lights;
- 4) Press  **ESC** to go back to the home page.

DEMO MODE







By enabling this mode, the main functions of the machine are shown on the display:

- 1) Press  **(B2)** to enter the menu;
- 2) Press **← (B10)** or **→ (B8)** until the display shows  **Demo mode**;
- 3) Press  to start the demo;
- 4) To exit from the demo mode, first turn the appliance off by pressing the button  **(A7)**. Press again the button  to go back to the home page.

DEFAULT VALUES





This resets all menu settings and programmed quantities back to the default values (with the exception of the language which remains as set).

To reset the default values, proceed as follows:

- 1) Press  **(B2)** to enter the menu;
- 2) Press **← (B10)** or **→ (B8)** until the display **(B)** shows  **Default values**. Press ;
- 3) Press  **Reset all** to reset all the profiles to the original parameters, otherwise select the required profile (e.g. **User 1**);
- 4) **Return to factory**: press  **OK** to confirm (or  **ESC** to leave parameters unaltered);
- 5) **Factory settings**: press  **OK** to confirm.

STATISTICS

This function displays statistical data relating to the machine. To display the statistics, proceed as follows:





































- 1) Press  **(B2)** to enter the menu;
- 2) Press **← (B10)** or **→ (B8)** until the display **(B)** shows  **Statistics**;
- 3) Press  : it is possible to check all the available statistics by pressing **←** or **→**;
- 4) Press  **ESC**: to go back to the home page.

USING THE APPLIANCE

MAKING COFFEE



SELECTING THE COFFEE AROMA



Select the required aroma from the home page by pressing  AROMA (B6):

	(see "Making coffee using pre-ground coffee")
     	AROMA EXTRA LIGHT
     	LIGHT AROMA
     	MEDIUM AROMA
     	STRONG AROMA
     	X-STRONG AROMA
     	Custom (if programmed) / Standard

After delivering the beverage, the aroma setting is reset to the  value.

SELECTING THE COFFEE QUANTITY

From the home page select the required quantity of coffee in the cup by pressing   QUANTITY (B7):

    	Small size (SMALL)
    	Medium size (MEDIUM)
    	Large size (LARGE)
    	Extra large size (EXTRA LARGE)
    	Custom quantity (if programmed) / Standard quantity

After delivering the beverage, the quantity setting is reset to the  value.

MAKING COFFEE USING COFFEE BEANS



CAUTION

Do not use green, caramelised or candied coffee beans as they could stick to the coffee mill and make it unusable.

- 1) Fill the beans container (A16) (Fig. 24) with coffee beans;

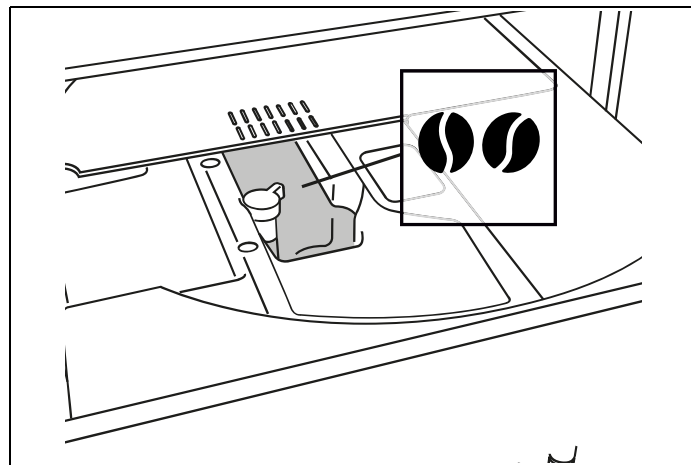

Fig. 24

- 2) Place a cup under the coffee spout (A13);
- 3) Lower the spout so that it is as near as possible to the cup (Fig. 25): this helps achieve a better cream;

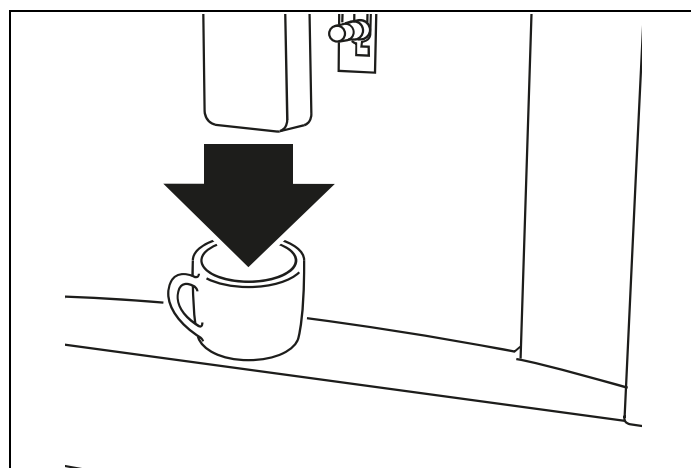



Fig. 25

- 4) Press  (B10) or  (B8) until the required coffee is displayed;

- 5) Then select your required coffee from the home page:

- Espresso
- Doppio+
- Coffee
- Long
- 2X Espresso

USING THE APPLIANCE

- **Americano**

6) Preparation begins and the display **(B)** shows the image of the selected beverage together with a progress bar which gradually fills as preparation proceeds.



NOTE

- It is possible to prepare 2 cups of **Espresso** coffee at the same time by also pressing **2x**  during the preparation of 1 **Espresso** (the image remains shown on the display for a few seconds at the start of preparation).
- While the machine is making coffee, delivery can be interrupted at any time by pressing **X STOP**.
- As soon as delivery has ended, to increase the quantity of coffee in the cup, just press **+ EXTRA**: once the desired quantity is reached, press **X STOP**.

Once the coffee has been made, the appliance is ready to make the next beverage.



NOTE

Various alarm messages may be displayed while using the appliance (**Fill water tank with fresh water**, etc.).

Their meaning is explained in section *Displayed messages*.

- For hotter coffee, see paragraph *Tips for a hotter coffee*.
- If the coffee comes out in drops, too weak and not creamy enough or too cold, read the tips in section *Adjusting the coffee mill* and the *Troubleshooting* chapter.
- Preparation of each coffee can be customised (see sections *Customising beverages* and *Memorising your personal profile*).
- If "Energy Saving" mode is active, the first coffee may take a few seconds before it is delivered.

MAKING COFFEE USING PRE-GROUND COFFEE



CAUTION

Never add pre-ground coffee when the machine is off in order to avoid it spreading through the inside of the machine and making it dirty. This could damage the appliance.





CAUTION

Never use more than 1 level measure **(C2)** or it could dirty the inside of the coffee machine or block the funnel **(A21)**.



NOTE

If you use pre-ground coffee, you can only make one cup of coffee at a time.

- 1) Repeat Press  **Aroma (B6)** until the display **(B)** shows  (pre-ground).
- 2) Open the cover **(A15)** and the pre-ground door **(A23)**.
- 3) Make sure the funnel **(A21)** is not blocked, then add one level measure of pre-ground coffee (Fig. 26).

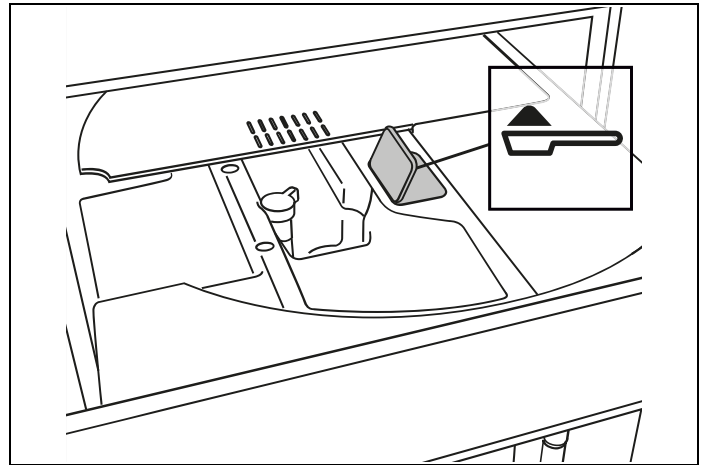

Fig. 26

- 4) Place a cup under the coffee spouts **(A13)** (Fig. 25).
- 5) Then select your required coffee (**Espresso, coffee, Long**, etc.) from the home page;
- 6) Preparation begins and the image of the selected beverage appears on the display, together with a progress bar which gradually fills as preparation progresses.

USING THE APPLIANCE

NOTE



- While the machine is making coffee, delivery can be interrupted at any time by pressing **STOP**.
- As soon as delivery has ended, to increase the quantity of coffee in the cup, just press **EXTRA**: once the desired quantity is reached, press **STOP**.

Once the coffee has been made, the appliance is ready to make the next beverage.



CAUTION

Making **Long** coffee ☕:

Halfway through preparation, the display will show message **Add pre-ground coffee**. Add one level measure of pre-ground coffee and press **OK**.

ADJUSTING THE COFFEE MILL

The coffee mill should not require adjusting, at least initially, because it has already been set by default in order to prepare coffee correctly.

However, if after making the first few coffees you find that the coffee is either too weak and not creamy enough or delivery is too slow (a drop at a time), this can be corrected by adjusting the grinding adjustment dial (Fig. 27).

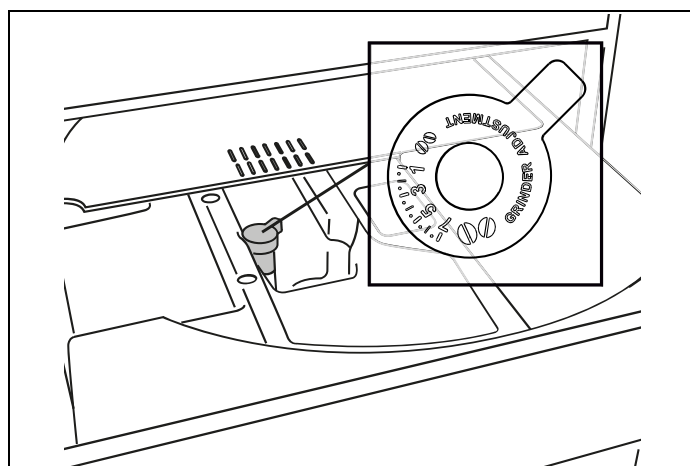

Fig. 27

NOTE



The grinding adjustment dial must only be turned when the coffee mill is in operation during the initial phase of coffee preparation.

USING THE APPLIANCE

If the coffee comes out too slowly or does not come out at all, a message will be shown **Ground too fine**. **Adjust grind level**, turn the coffee mill dial one or two clicks clockwise.

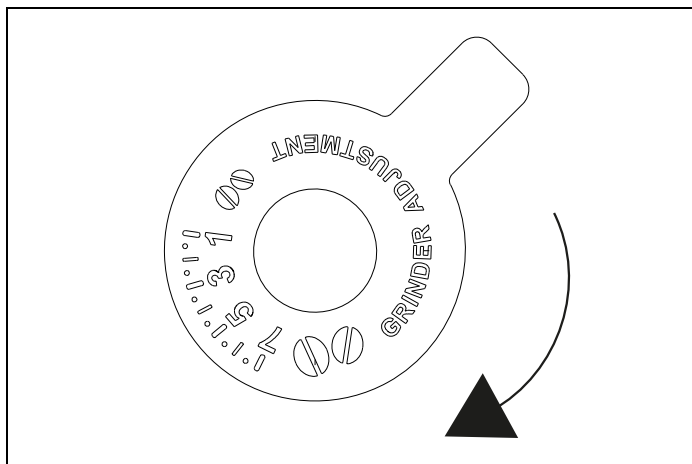

Fig. 28

For fuller bodied creamier coffee, turn one click anti clockwise towards 1 (do not turn more than one click at a time otherwise the coffee could come out one drop a drop at a time).

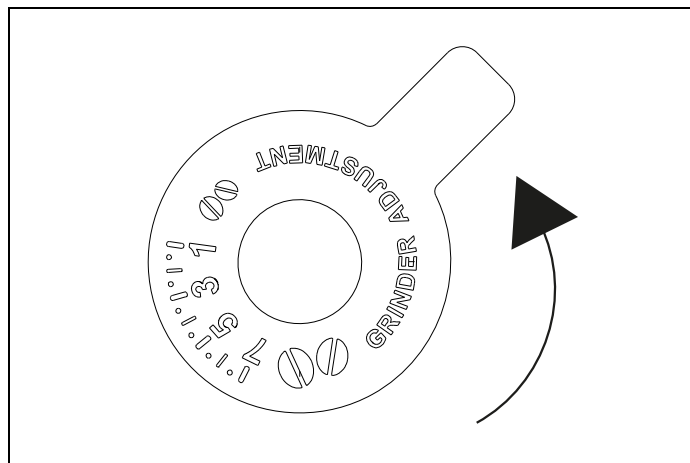

Fig. 29

The effect of these adjustments will only be evident after at least **2 cups** of coffee have been delivered. If this adjustment does not obtain the desired result, repeat the correction by turning the dial another click.

TIPS FOR A HOTTER COFFEE

It is recommended to:

- carry out a rinse cycle by selecting the "Rinsing" function in the settings menu (paragraph *RINSING*);
- warm the cups with hot water (using the hot water function, see section *DELIVERING HOT WATER*);
- increase the coffee temperature in the settings menu (see section *Coffee temperature*).

USING THE APPLIANCE

COFFEE RECIPES

ESPRESSO			
ORIGIN	Italy		
PROCESS	<i>Grinding</i>	Coffee powder	6-11gr (according to aroma)
	<i>Brewing</i>	Pre-infusion	high pressure (9-12 bar)
		Infusion	
RESULT IN CUP	Default Quantity		~ 40ml
	Cream		compact and nut-coloured
	Taste		intense
OCCASION OF USE	short-term pleasure, every moment of the day.		

COFFEE			
ORIGIN	Germany & Central Europe		
PROCESS	<i>Grinding</i>	Coffee powder	6-11gr (according to aroma)
	<i>Brewing</i>	Pre-infusion	high pressure (9-12 bar)
		Infusion	
RESULT IN CUP	Default Quantity Cream		~ 180ml
	Cream		thinner than espresso
	Taste		balanced and delicate
OCCASION OF USE	long-lasting pleasure, every moment of the day		

LONG			
ORIGIN	USA, Australia		
PROCESS	<i>Grinding</i>	Coffee powder	2 grindings of 5-9gr (according to aroma)
	<i>Brewing</i>	Pre-infusion	no pre infusion
		Infusion	
RESULT IN CUP	Default Quantity		~ 160ml
	Cream		thinner and lighter than espresso
	Taste		perfect for drip coffee lovers
OCCASION OF USE	long-lasting pleasure, every moment of the day		

USING THE APPLIANCE

DOPPIO+

ORIGIN	Italy		
PROCESS	<i>Grinding</i>	Coffee powder	15gr
	<i>Brewing</i>	Pre-infusion	reduced pre infusion
		Infusion	higher pressure than espresso
RESULT IN CUP	Default Quantity		~ 120ml
	Cream		thicker and darker than espresso
	Taste		stronger than espresso
OCCASION OF USE	need for energy		

AMERICANO

ORIGIN	USA, UK		
PROCESS	<i>Grinding</i>	Coffee powder	6-11gr (according to aroma)
	<i>Brewing</i>	Pre-infusion	•
		Infusion	high pressure (9-12 bar)
RESULT IN CUP	Default Quantity		~ 150ml
	Cream		thinner and lighter than espresso
	Taste		Light and delicate
OCCASION OF USE	need for energy		

USING THE APPLIANCE

MAKING MILK-BASED HOT DRINKS



NOTE

To avoid milk with little froth or large bubbles, always clean the milk container lid (D2) and hot water connection nozzle (A10) as described in sections *Cleaning the milk container after use*, *Cleaning the milk container (D)* and *Cleaning the hot water/steam connection nozzle*.

FILLING AND ATTACHING THE MILK CONTAINER

Remove the lid (D2) (Fig. 30);

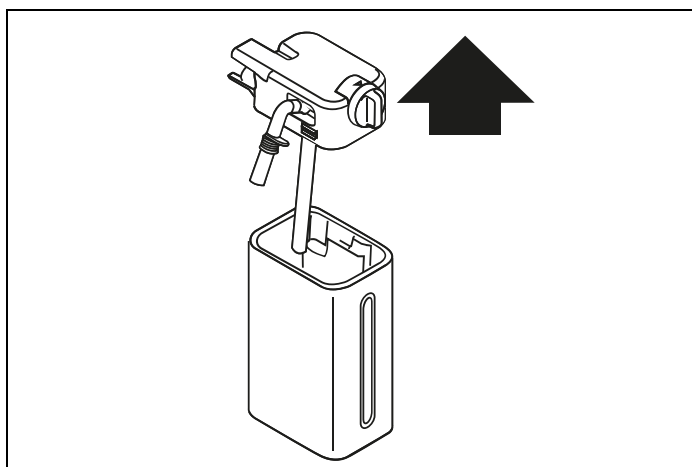

Fig. 30

Fill the milk container (D3) with a sufficient quantity of milk, not exceeding the MAX level marked on the container (Fig. 31). Each mark on the side of the container corresponds to about 100 ml of milk;

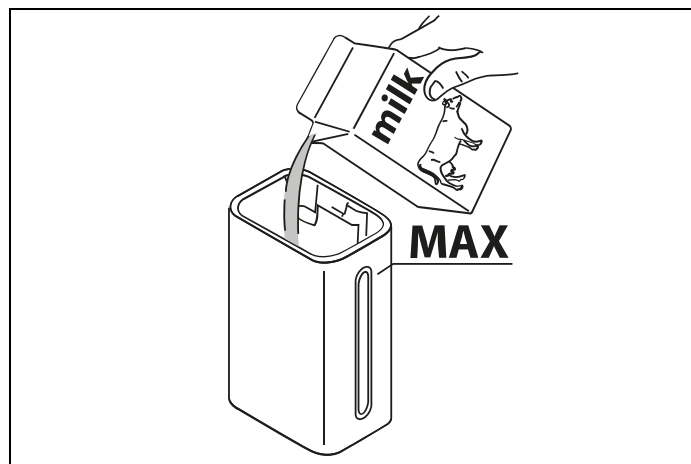

Fig. 31



NOTE

For a denser and more even froth, you must use skimmed or partially skimmed milk at refrigerator temperature (about 5°C).

If "Energy Saving" mode is enabled, there may be a few seconds delay before the beverage is delivered.

USING THE APPLIANCE

Make sure the milk intake tube (**D4**) is correctly inserted in the bottom of the milk container lid (Fig. 32);

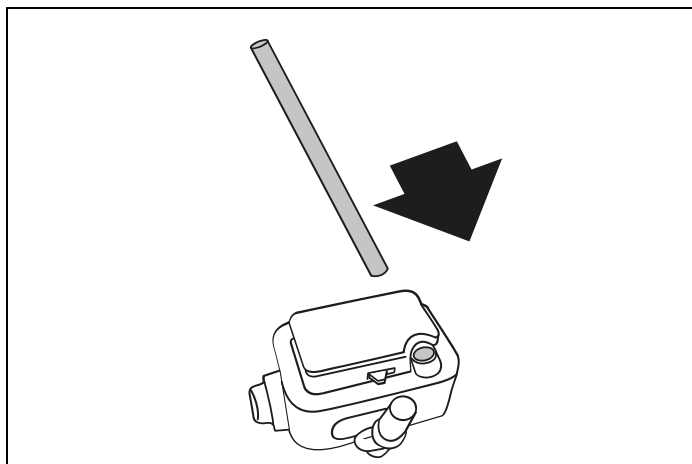

Fig. 32

Place the lid back on the milk container;

Remove the hot water/steam spout (**C6**) (Fig. 33);

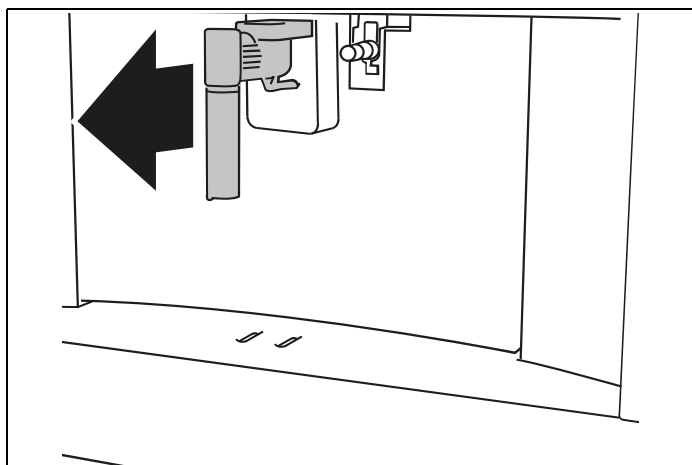

Fig. 33

By pushing the bottom attach the milk container (**D**) to the nozzle (**A10**) (Fig. 34): the machine will let out a noise signal (if the sound notification function is enabled);

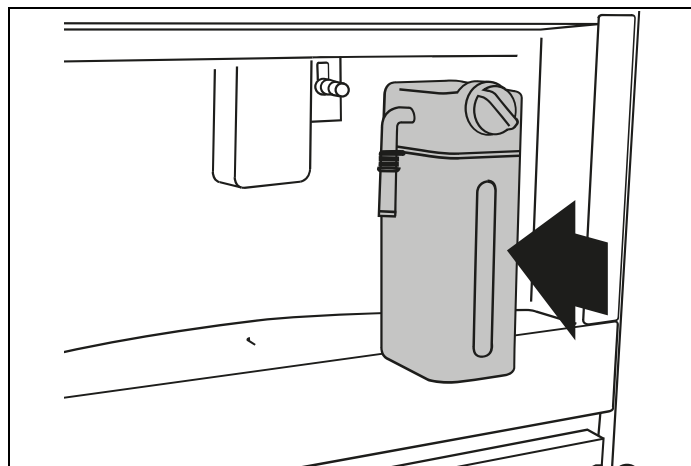

Fig. 34

Place a sufficiently large cup under the coffee spouts (**A13**) and frothed milk spout (**D5**); adjust the length of the milk spout, to move it nearer to the cup, simply pulling it downwards (Fig. 35).

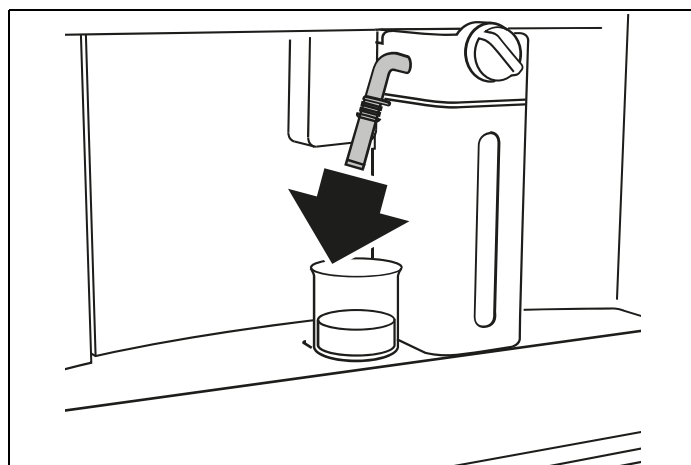

Fig. 35

Follow the instructions below for each function.

USING THE APPLIANCE

ADJUSTING THE AMOUNT OF FROTH

Turn the froth adjustment dial (**D1**) on the milk container lid, to adjust the amount of froth on the milk delivered while making the drinks. Follow the tips in the table below:

DIAL POSITION	RECOMMENDATION
 No froth	Caffelatte (hot milk)
 Min. froth	Latte macchiato
 Max. froth	Cappuccino (frothed milk)

MAKING MILK-BASED DRINKS AUTOMATICALLY

Fill the milk container (**D**) and attach it as described above:

Select the required beverage from the homepage:

- Cappuccino
- Latte macchiato
- Caffelatte
- Hot milk
- Cappuccino+
- Espresso macchiato
- Flat white
- Cappuccino mix



On the display (**B**) the machine recommends turning the foam adjustment dial (**D1**) based on the foam requirements for the original recipe: therefore turn the dial on top of the milk container lid (**D2**) and confirm the selection by pressing  OK.

After a few seconds, preparation begins automatically and an image of the selected beverage appears on the display, together with a progress bar which gradually fills as preparation progresses.



NOTE

General indications when preparing all milk based drinks

- 1) press  ESC to interrupt preparation completely and go back to the homepage.
- 2) press  STOP to interrupt milk or coffee delivery and move on to the next delivery (if applicable) to complete the beverage.
- 3) At the end of delivery, to increase the quantity of coffee in the cup, press  EXTRA
- 4) Preparation of each milk based drink can be customised (see sections *Customising beverages* and *Memorising your personal profile*).
- 5) Do not leave the milk container out of the fridge for a longtime: as the temperature increases (5°C ideal), the quality of the foam decreases.

Once the coffee has been made, the appliance is ready to make the next beverage.

USING THE APPLIANCE

CLEANING THE MILK CONTAINER AFTER USE



DANGER

The following cleaning operations should be performed each time a milk beverage is delivered.

When cleaning the internal tubes of the milk container, a little hot water and steam leak out of the frothed milk spout (D5). Avoid contact with splashes of water. Each time a milk function is used, **Turn milk froth adjustment knob to <CLEAN>** appears on the display and the milk frother lid must be cleaned:

- 1) Leave the milk container (D3) in the machine (you do not need to empty it);
- 2) Place a cup or other recipient under the frothed milk spout (Fig. 36);

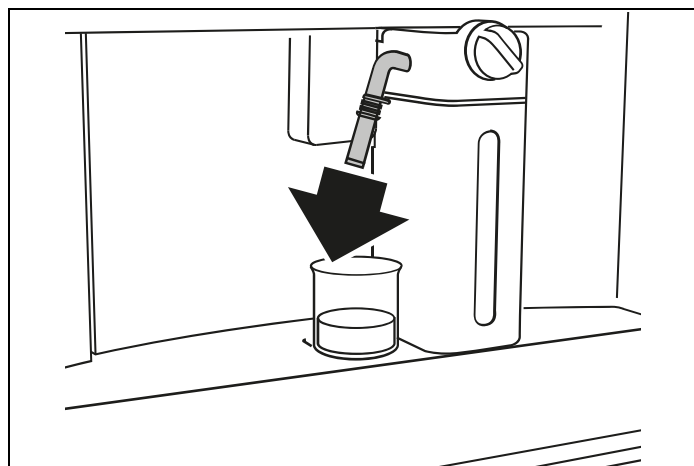

Fig. 36

- 3) Turn the foam adjustment dial (D1) to **CLEAN** (Fig. 37): **Cleaning milk container** (Fig. 38) appears on the display (B) together with a bar which gradually fills as cleaning proceeds. Cleaning stops itself automatically;

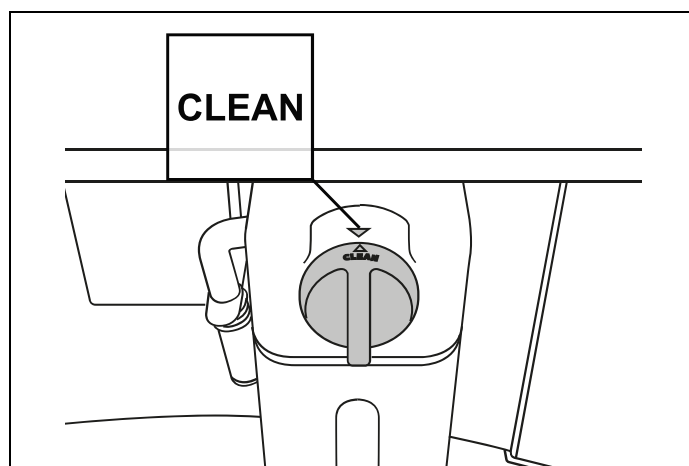

Fig. 37

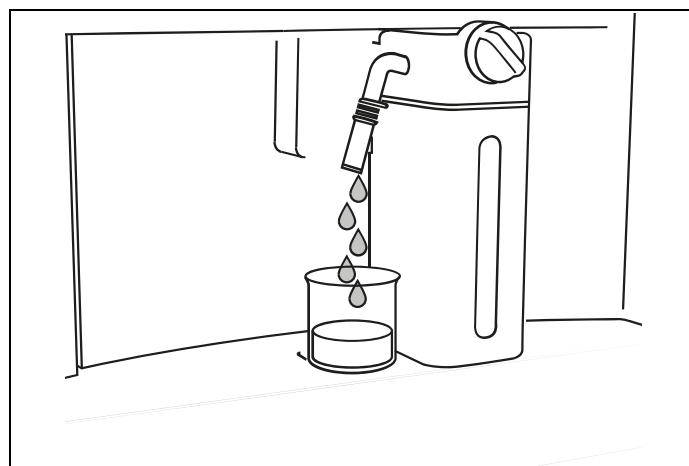

Fig. 38

USING THE APPLIANCE

- 4) Turn the dial back to one of the froth selections;
- 5) Remove the milk container and always clean the steam connection nozzle (A10) with a clean cloth (Fig. 39).

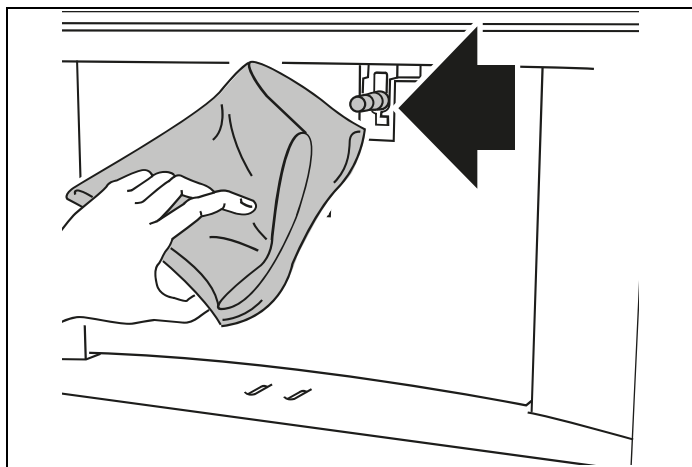



Fig. 39

NOTE





- If a number of milk based drinks need to be made, only clean the milk container after preparing the last beverage. To proceed with making the next beverages, when the **CLEAN** message is displayed, press  ESC
- If the milk container does not get cleaned, the symbol  appears on the display as a reminder that the milk container needs cleaning.
- The milk container can be kept in the refrigerator.
- In some cases, to carry out the cleaning the appliance requires a short time to heat up.

DELIVERING HOT WATER



DANGER

Do not leave the appliance unattended while hot water is being delivered.

- Make sure the hot water/steam spout (C6) is attached correctly to the hot water/steam connection nozzle (A10);
- Place a container under the spout (as close as possible to avoid splashes);
- Select  **Hot water** from the homepage. The corresponding image appears on the display (B), together with a progress bar which fills gradually as preparation proceeds;
- The machine delivers hot water, then delivery stops automatically. To interrupt hot water delivery manually, press  STOP

NOTE



If "Energy Saving" mode is active, there may be a few seconds delay before hot water is delivered.

Preparation of hot water can be customised (see sections *Customising beverages* and *Memorising your personal profile*).



USING THE APPLIANCE

STEAM DELIVERY



DANGER

Do not leave the appliance unattended while steam is being delivered.

- 1) Make sure the hot water/steam spout (**C6**) is attached correctly to the hot water/steam connection nozzle (**A10**);
- 2) Fill a container with the liquid to be heated or frothed and immerse the hot water/steam spout in the liquid;
- 3) Select  **Steam** from the homepage. The corresponding image appears on the display (**B**), together with a progress bar which fills gradually as preparation proceed and after a few seconds, steam to heat the liquid is delivered from the hot water/steam spout;
- 4) When the required temperature or level of froth is reached, interrupt steam delivery by pressing  **STOP**



CAUTION

Always stop steam delivery before extracting the container containing the liquid to avoid burns from splashes.



NOTE

If “Energy saving” mode is active, there may be a few seconds delay before steam is delivered.

TIPS FOR USING STEAM TO FROTH MILK

When choosing the size of the container, bear in mind that the liquid doubles or triples in volume.

For a richer denser froth, use skimmed or partially skimmed milk at refrigerator temperature (about 5°C).

For a creamier froth, rotate the container with slow movements in an upward motion.

To avoid milk with poor froth or large bubbles, always clean the spout (**C6**) as described in the following paragraph.

CLEANING THE HOT WATER/STEAM SPOUT AFTER USE

Always clean the hot water/steam spout (**C6**) after use to avoid the build-up of milk residues and prevent it from clogging.

- 1) Place a container under the hot water/steam spout and let a little water out (see section *DELIVERING HOT WATER*). Then stop the delivery of hot water by pressing  **STOP**.
- 2) Wait a few minutes for the hot water/steam spout to cool down; then extract it (Fig. 33). Hold the spout steady with one hand and with the other, turn and detach the cappuccino maker pulling it downwards (Fig. 40).

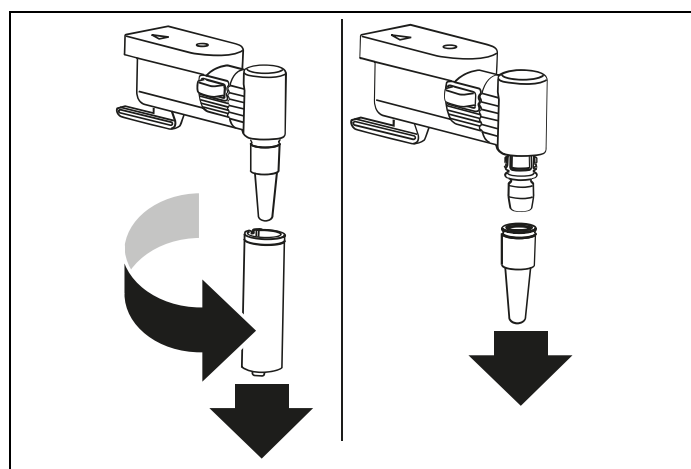

Fig. 40

- 3) Also remove the steam connection nozzle by pulling it downwards (Fig. 40).
- 4) Check the hole in the connection nozzle is not blocked. If necessary, clean using a toothpick.
- 5) Wash all parts of the spout thoroughly with a sponge and warm water.
- 6) Attach the connection nozzle and the cappuccino maker onto the spout by pushing it upwards and turning it clockwise until it is secure.

USING THE APPLIANCE

MILK-BASED RECIPES

CAPPUCCINO

ORIGIN	Italy	
PROCESS	Coffee	balanced (~ 80ml)
	Milk	balanced (~ 70ml)
	Milk foam	maximum level
	Delivery order	milk first, coffee afterwards
RESULT IN CUP	Visual	separate layers of foam, coffee and milk
	Milk foam	white with milky taste
OCCASION OF USE	every moment of the day, people who want to taste coffee and milk separately	

CAPPUCCINO+

ORIGIN	Italy	
PROCESS	Coffee	Doppio+ (~ 120ml)
	Milk	~ 70ml
	Milk foam	maximum level
	Delivery order	milk first, coffee afterwards
RESULT IN CUP	Visual	darker than cappuccino
	Milk foam	separate layers of foam, coffee and milk, with milky taste
OCCASION OF USE	need for energy, people who want a cappuccino with a strong coffee taste	

CAPPUCCINO MIX

ORIGIN	Italy	
PROCESS	Coffee	balanced (~ 80ml)
	Milk	balanced (~ 70ml)
	Milk foam	maximum level
	Delivery order	coffee first, milk afterwards
RESULT IN CUP	Visual	uniformly brown milk drink
	Milk foam	light brown with coffee taste
OCCASION OF USE	every moment of the day, people who loves melted milk and coffee tastes	

USING THE APPLIANCE

LATTE MACCHIATO

ORIGIN	Italy	
PROCESS	Coffee	~ 60ml
	Milk	~ 90ml
	Milk foam	medium level
	Delivery order	milk first, coffee afterwards
RESULT IN CUP	Visual	separate layers of foam, coffee and milk
	Milk foam	white with milky taste
OCCASION OF USE	every moment of the day, people who want to taste coffee and milk separately	

CAFFELATTE

ORIGIN	Italy	
PROCESS	Coffee	~ 60ml
	Milk	~ 240ml
	Milk foam	medium level
	Delivery order	milk first, coffee afterwards
RESULT IN CUP	Visual	separate layers, coffee and milk
	Milk foam	little layer of white foam with milky taste
OCCASION OF USE	every moment of the day, people who want to taste coffee and milk separately	

ESPRESSO MACCHIATO

ORIGIN	Italy	
PROCESS	Coffee	6-11gr (according to aroma) (~ 30ml)
	Milk	few drops (~ 20ml)
	Milk foam	maximum level
	Delivery order	coffee first, milk afterwards
RESULT IN CUP	Visual	black with one thin layer or milk foam
	Milk foam	
OCCASION OF USE	every moment of the day, people who want to taste a slightly sweet espresso	

USING THE APPLIANCE

CUSTOMISING BEVERAGES

The aroma (for drinks where required) and length of the drinks can be customised.

- 1) Make sure that the profile for which customising the drink is required is active: it is actually possible to select the drinks MY for all 6 profiles ;
- 2) From the homepage, press **MY** (B1);
- 3) Choose the beverage you wish to customise in order to access the customising screens: the relative accessories must be inserted
- 4) (Beverages with coffee only) **Choose aroma**: Select the required aroma by pressing **−** or **+** and press **✓** OK;
- 5) **Customising coffee or water quantity**: Preparation begins and the appliance displays the quantity customising screen in the form of a vertical bar. The star alongside the bar represents the current quantity set.
- 6) When the amount reaches the minimum quantity you can set, the display shows **✕** STOP.
- 7) Press **✕** STOP when the required quantity in the cup is reached.
- 8) **Save new settings?**: Press YES or NO.

The appliance confirms if the values have been saved or not (depending on the previous selection): press **✓** OK.

The appliance goes back to the homepage.



NOTE

- Milk based drinks: the coffee aroma is saved first, followed by the quantity of first milk, then coffee;
- Hot water: the appliance supplies hot water: press **✕** STOP to save the desired quantity.
- It is possible to come out of programming by pressing **↳** ESC: the values will not be saved.

MEMORISING YOUR PERSONAL PROFILE

The appliance allows you to memorise 6 different profiles, each associated with a different icon.

In every profile the customised **My aroma** and **Size** values are saved (see section *Customising beverages* **MY**) and the order in which all the beverages are displayed is based on the frequency of selection.

To select or enter a profile, press on the profile currently in use (B11), press **←** (B10) or **→** (B8) until the required profile is displayed, then press on the profile.



NOTE

Profile  **Guest**: select this profile to deliver beverages with the default settings.

The **MY** function is not active.

CLEANING

Clean all the components thoroughly, taking particular care with parts in contact with the coffee and milk.

Cleaning and user maintenance shall not be made by children without supervision. Never immerse the appliance in water.



CAUTION

To prevent damage to the appliance do not use alkaline cleaning agents when cleaning, use a soft cloth and a mild detergent.

CLEANING AND MAINTENANCE OF MATERIALS IN CONTACT WITH FOOD

- The first time you use the appliance, or if it is not used for more than 3 or 4 days, rinse all removable accessories which may come into contact with water or milk with hot water.
- If the appliance is not used for more than 3 or 4 days, before making the first beverage, rinse the water circuit as described in this Instruction for Use.
- You should carry out automatic cleaning and guided maintenance scrupulously when proposed by the appliance through the display or the lights described in the manual.
- Fill with fresh drinking water.
- Empty the water tank if the appliance is not used for extended periods (holidays etc.).
- Replace the water if the appliance is not used for more than two days.

CLEANING THE MACHINE

The following parts of the machine must be cleaned regularly:

- appliance internal circuit;
- coffee grounds container (**A4**);
- drip tray (**A14**);
- water tank (**A12**);
- coffee spouts (**A13**);
- pre-ground coffee funnel (**A21**);
- infuser (**A5**), accessible after opening the service door (**A2**);
- milk container (**D**);
- water/steam connection nozzle (**A10**);
- control panel (**B**).



IMPORTANT

Do not use solvents, abrasive detergents or alcohol to clean the coffee machine. It is not necessary to use chemical products to clean the machine.

None of the components of the appliance can be washed in a dishwasher with the exception of the milk container (**D**).

Do not use metal objects to remove encrustations or coffee deposits as they could scratch metal or plastic surfaces.

CLEANING THE APPLIANCE INTERNAL CIRCUIT

If the appliance is not used for more than 3/4 days, before using it again, we strongly recommend switching it on and:

- performing 2/3 rinse cycles by selecting the "Rinse" function (paragraph *RINSING*);
- delivering hot water for a few seconds (section *DELIVERING HOT WATER*).



NOTE

After cleaning, it is normal for the grounds container (**A4**) to contain water.

CLEANING

CLEANING THE COFFEE GROUNDS CONTAINER

When the display (B) shows the message **Empty grounds container** (Fig. 41) the grounds container must be emptied and cleaned. The appliance cannot be used to make coffee until the grounds container (A4) has been cleaned. Even if not full, the empty grounds container message is displayed 72 hours after the first coffee has been prepared (for the 72 hours to be calculated correctly, the machine must never be turned off with the main switch).

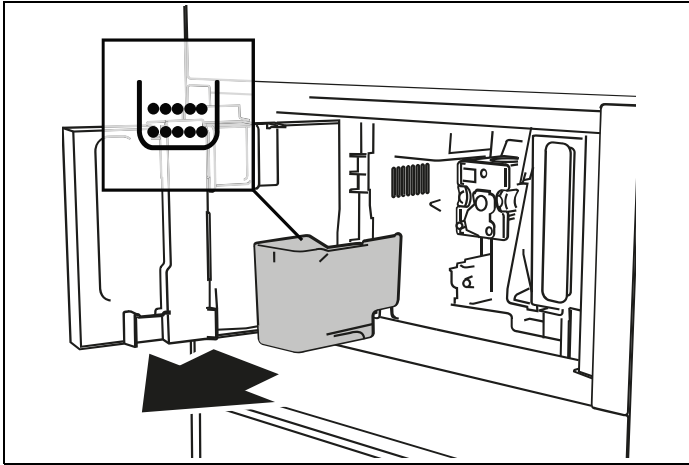

Fig. 41

To clean (with the machine on):

1) Open the bottom door by rotating it downwards (Fig. 42).

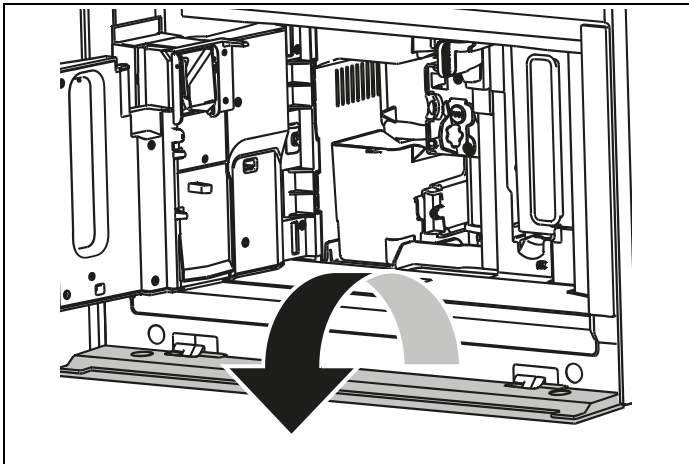

Fig. 42

2) Open the door.

3) Remove the drip tray (A14) (Fig. 43), empty and clean it.

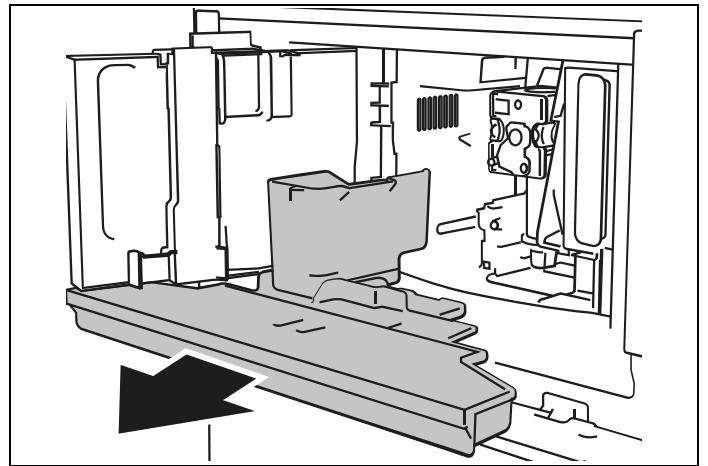

Fig. 43

4) Carefully empty and clean the coffee grounds container (A4) taking care to remove all the residue that can be deposited on the bottom: the brush provided (C5) features a spatula especially for this job.



IMPORTANT

When removing the drip tray it is obligatory to always empty the grounds container even if it contains few grounds. If this is not done, when you make the next coffees, the grounds container may fill up more than expected and clog the machine.

CLEANING

CLEANING THE DRIP TRAY

The drip tray (**A14**) is fitted with a level indicator (red) showing the level of water it contains (Fig. 44). Before the indicator protrudes from the cup tray (**A1**), the drip tray must be emptied and cleaned, otherwise the water may flow over the edge and damage the appliance, the surface it rests on or the surrounding area.

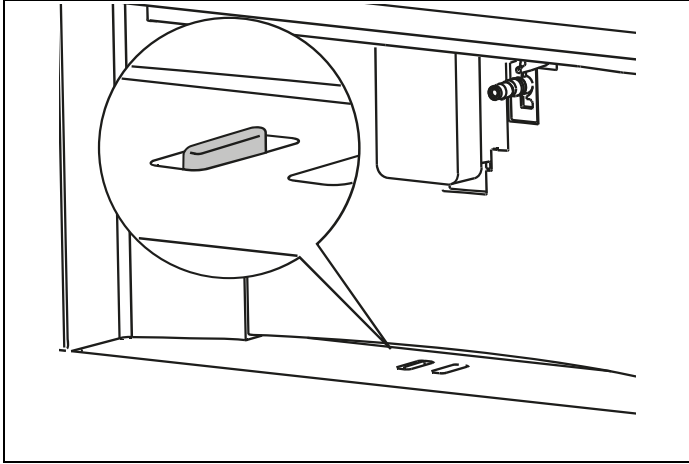

Fig. 44

To remove the drip tray, proceed as follows:

- Open the door (Fig. 42). Remove the drip tray and coffee grounds container (**A4**) (Fig. 43);
- Empty the drip tray and grounds container and wash them;
- Replace the drip tray complete with grounds container.

CLEANING THE INSIDE OF THE COFFEE MACHINE



DANGER

Before cleaning internal parts, the machine must be turned off (see section *TURNING THE APPLIANCE OFF*) and unplugged from the mains power supply. Never immerse the coffee machine in water.

- Check regularly (about once a month) that the inside of the appliance (accessible after removing the drip tray - **A14**) is not dirty.
- If necessary, remove coffee deposits with the brush (**C5**) supplied and a sponge. Remove all the residues with a vacuum cleaner (Fig. 45).

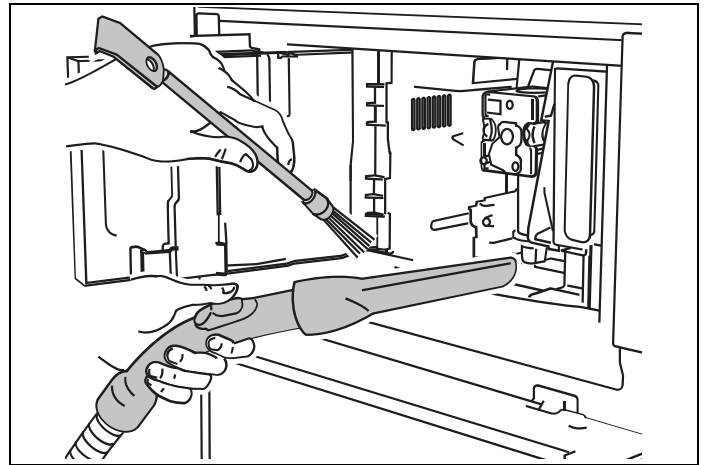

Fig. 45

CLEANING THE WATER TANK

Clean the water tank (**A12**) regularly (about once a month) and whenever you replace the water softener filter (**C4**) (if provided) with a damp cloth and a small amount of mild washing up liquid.: rinse carefully before filling and replacing the tank;

Remove the filter (if present) and rinse with running water;

Replace the filter (if provided), fill the tank with fresh water and replace the tank;

(Models with water softener filter only) Deliver about 500 ml of hot water to reactivate the filter.

CLEANING

CLEANING THE COFFEE SPOUTS

Clean the coffee spouts (A13) regularly with a sponge or cloth (Fig. 46);

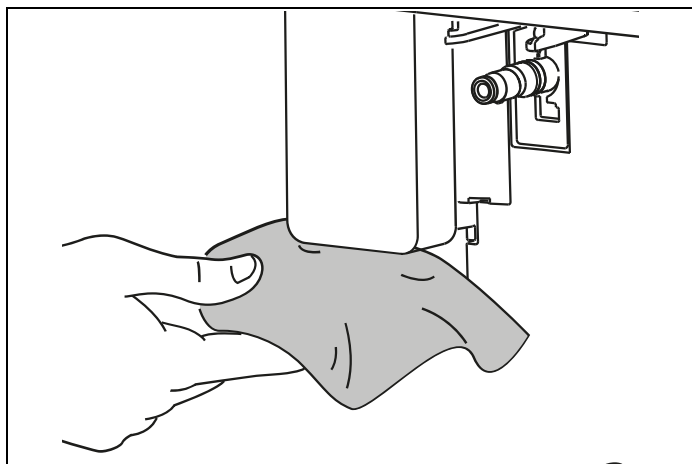

Fig. 46

Check that the holes in the coffee spouts are not blocked. If necessary, remove coffee deposits with a toothpick (Fig. 47).

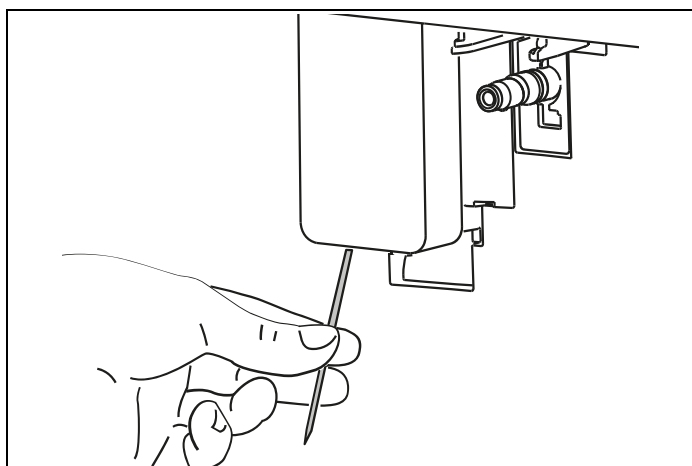

Fig. 47

CLEANING THE PRE-GROUND COFFEE FUNNEL

Check regularly (about once a month) that the pre-ground coffee funnel (A21) is not blocked. If necessary, remove coffee deposits with the brush (C5) supplied.

CLEANING THE INFUSER

The infuser must be cleaned at least once a month.



IMPORTANT

The infuser (A5) must not be removed when the appliance is on. Do not use force to remove the infuser.

- 1) Make sure the machine is correctly turned off (see *TURNING THE APPLIANCE OFF*).
- 2) Open the service door.
- 3) Remove the drip tray and waste coffee container (Fig. 43).
- 4) Press the two coloured release buttons inwards and at the same time pull the infuser outwards (Fig. 48).

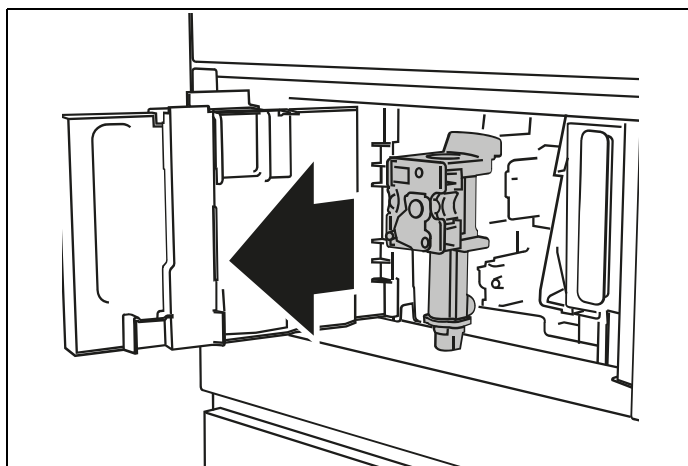

Fig. 48



IMPORTANT

Do not use washing up liquid to clean the infuser to avoid removing the lubricant applied to the inside of the piston.

- 1) Soak the infuser in water for about 5 minutes, then rinse.
- 2) After cleaning, replace the infuser (A5) by sliding it onto the internal support and pin at the bottom, then push the PUSH symbol fully in until it clicks into place (Fig. 49).

CLEANING

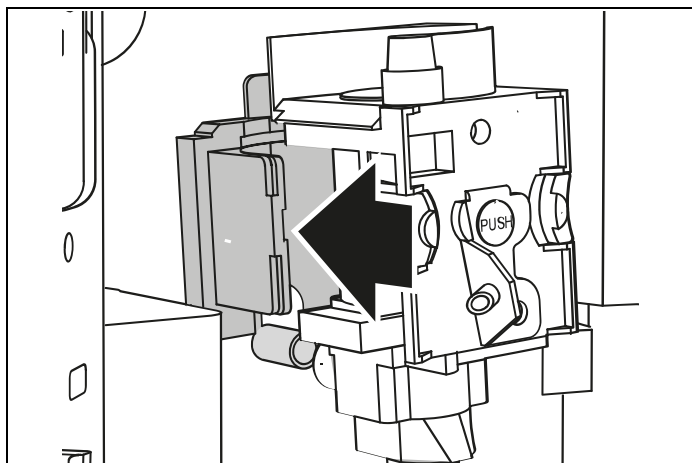

Fig. 49

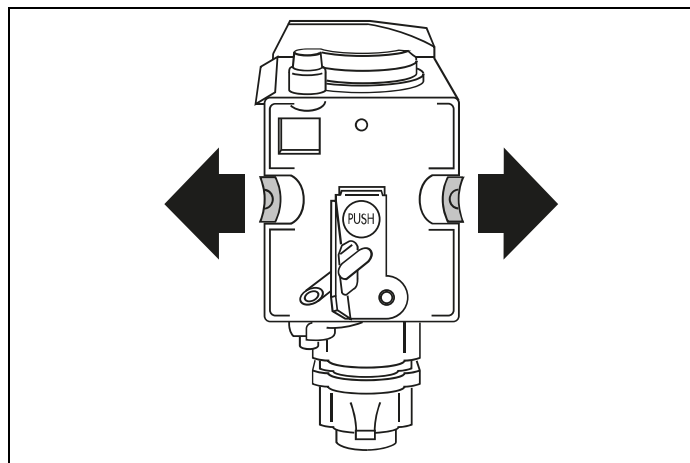

Fig. 51



NOTE

If you encounter difficulty inserting the infuser, (before inserting it) you must adapt it to the right dimension by pressing it forcefully from the bottom and top as shown in the figure Fig. 50 .

- 1) Once inserted, make sure the two coloured release buttons have snapped out (Fig. 51).
- 2) Replace the drip tray and waste coffee container.
- 3) Close the service door.

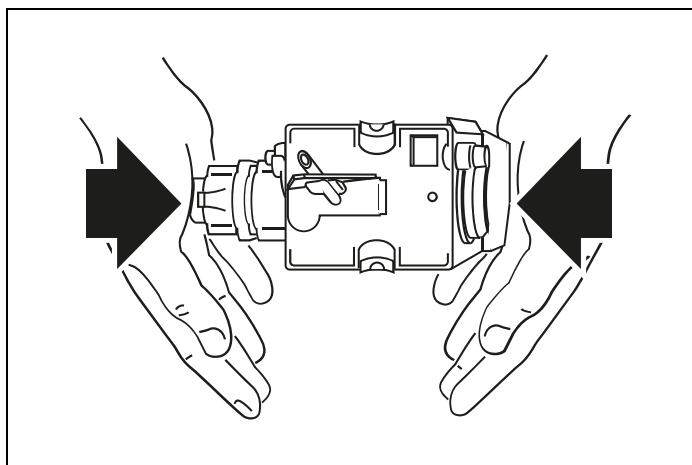

Fig. 50

CLEANING

CLEANING THE MILK CONTAINER (D)

Clean the milk container after each time you prepare milk, as described below:

- Lift and remove the lid (D2);
- Extract the milk container (D3) from the thermal casing (D6), holding it by the two side grips.



IMPORTANT

The thermal casing must not be filled or immersed in water: to clean it wipe with a damp cloth.

- Remove the milk spout (D5) and intake tube (D4).
- Turn the froth adjustment dial clockwise to the "INSERT" position (Fig. 52) and pull off.

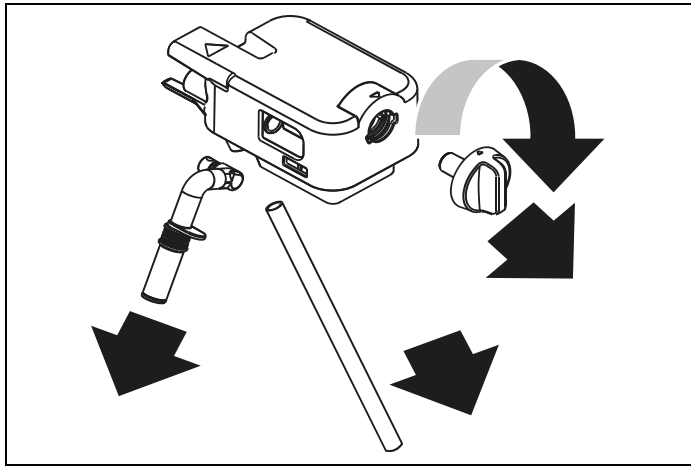

Fig. 52

- Wash all the components of the frother thoroughly with hot water and mild washing-up liquid. All components and the container are dishwasher safe, placing them in the top basket of the dishwasher. Pay particular attention to check in the hollow and groove under the dial (Fig. 53) that no milk residues remain: scrape any residue from the groove with a toothpick.

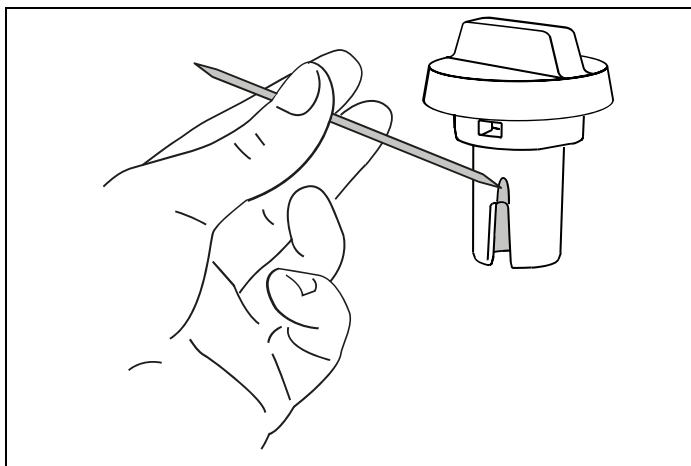

Fig. 53

- Rinse inside the froth adjustment dial seat (Fig. 54) and the milk frother connector hole using running water.

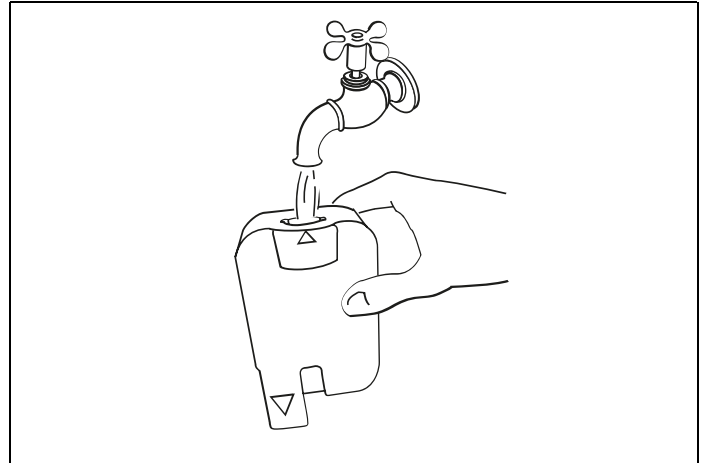

Fig. 54

- Check as well that the intake tube and spout are not clogged with milk residues.
- Replace the dial, lining up the arrow with the word "INSERT", the spout and milk intake tube.
- Place the milk container in the thermal casing.
- Place the lid back on the milk container.

CLEANING THE HOT WATER/STEAM CONNECTION NOZZLE

Each time you prepare milk, clean the connection nozzle (A13) with a sponge to remove milk residues deposited on the seals (Fig. 39).

DESCALING



IMPORTANT



Before use, read the instructions and the labelling on the de-scaler packaging.

You should use de-scaler authorised by the manufacturer only. Using unsuitable de-scaler and/or performing de-scaling incorrectly may result in faults not covered by the manufacturer's guarantee.

De-scale the appliance when the display **(B)** shows message **Descaling needed**  : to de-scale immediately, press \checkmark OK and follow the instructions from point 4.

To postpone de-scaling to another time, press \hookrightarrow ESC : on the display the  symbol is a reminder that the appliance needs to be de-scaled (the message will be re-proposed every time the machine is switched on).

To access the de-scaling menu:

- Press  **(B2)** to enter the menu;
- Press \leftarrow **(B10)** or \rightarrow **(B8)** until the display shows **Descaling** ;
- Press  to start the de-scaling cycle then follow the instructions on the display;
- **Remove water filter** (Fig. 55): extract the water tank **(A12)**, remove the water softener filter **(C4)** (if present) and empty the water tank. Press \succ NEXT;

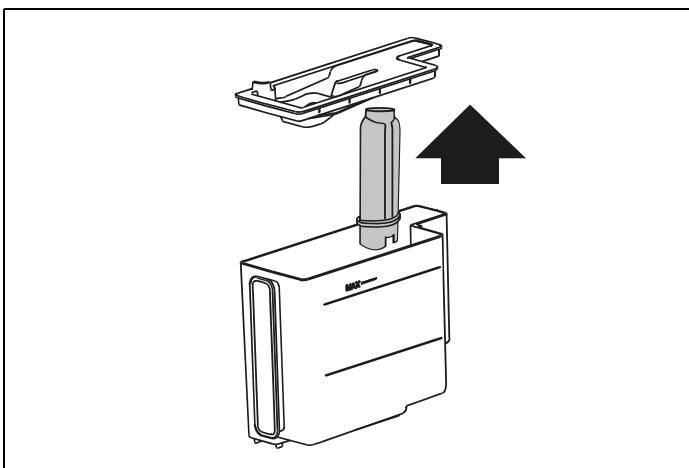

Fig. 55

- **Add descaler (up to level A)** (Fig. 56) ; Pour the de-scaler into the tank up to the level A marked inside the tank (equal to one 100 ml pack); then add water (one litre) up to level B; and put the water tank back in. Press \succ NEXT;

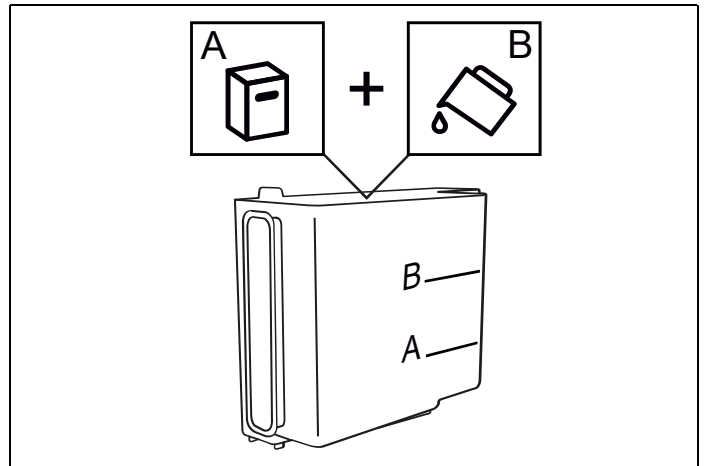

Fig. 56

- **Empty grounds container** (Fig. 43) : remove, empty and replace the drip tray **(A14)** and the ground container **(A4)**. Press \succ NEXT;
- **Place 2.5l container under outlet**: Place an empty container with a minimum capacity of 2.5 litres under the hot water/steam spout **(C6)** and coffee spouts **(A13)** (Fig. 22) ;



IMPORTANT

Hot water flows out of the hot water/steam spout which contains acid. Take care to avoid contact with splashes of this solution.

- 1) Press \checkmark OK to confirm that you have added the de-scaling solution. The display shows **Descaling Please wait**: the de-scale programme starts and the de-scaler liquid comes out of the hot water/steam and coffee spouts. A series of rinses and pauses is automatically carried out to remove all the scale residues from the inside of the coffee machine;

DESCALING

After about 25 minutes, de-scaling stops:

- 1) **Rinse and fill water tank** (Fig. 57): the appliance is now ready for a fresh water rinsing cycle. Empty the container used to collect the de-scaler solution and extract the water tank, empty, rinse under running water, fill with fresh water up to the MAX level and put back in the appliance;

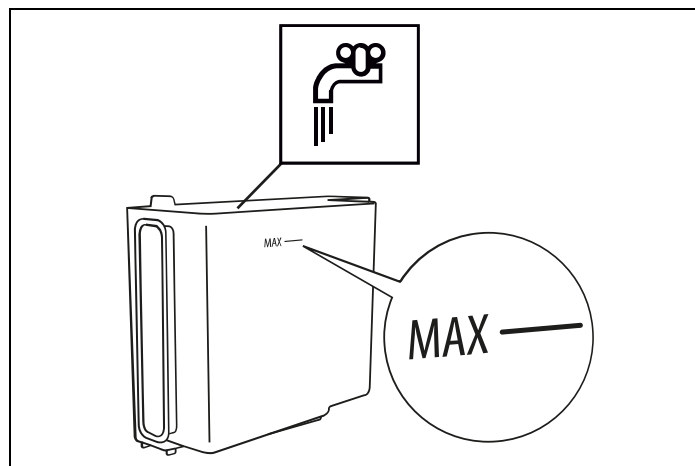

Fig. 57

- 2) **Place 2.5l container under outlet:** Place the container used to collect the de-scaler solution empty under the coffee spouts and hot water/steam spout (Fig. 22) again and press \checkmark OK ;
- 3) Hot water is delivered first from the coffee spouts and the display shows **Rinsing Please wait**;
- 4) When the water in the tank has run out, empty the container used to collect the rinsing water;
- 5) (If the filter is installed) **Insert filter into its housing** (Fig. 58). Press \triangleright NEXT and extract the water tank, reinsert the water softener filter if removed previously;

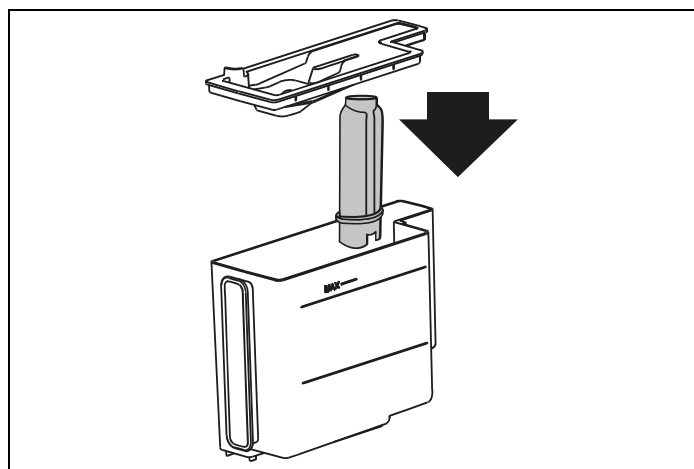

Fig. 58

- 6) **Rinse and fill water tank** (Fig. 44): Fill the tank up to the MAX level with fresh water;

- 7) **Insert water tank** (Fig. 20): Put the water tank back in the appliance;

- 8) **Place 2.5l container under outlet:** Place the empty container used to collect the de-scaler solution under the hot water/steam spout (Fig. 22) and press \triangleright NEXT;

- 9) Hot water is delivered from the hot water/steam spout and **Rinsing Please wait** is displayed.

- 10) **Empty drip tray** (Fig. 43): At the end of rinsing, remove, empty and replace the drip tray (A14) and grounds container (A4): press \triangleright NEXT ;

- 11) For a few seconds **Descaling complete** will be shown on the display; the appliance turn off.

De-scaling is complete.



NOTE

If the de-scaling cycle is not completed correctly (e. g. no electricity) we recommend repeating the cycle.

After de-scaling, it is normal for the grounds container (A4) to contain water.

- If the water tank has not been filled to the max level, at the end of de-scaling, the appliance requests a third rinse to guarantee that the de-scaler solution has been completely eliminated from the machine's internal circuits. Before starting rinsing, remember to empty the drip tray;
- The appliance may request de-scaling cycles at very short intervals. This is normal and due to the appliance's advanced control system

PROGRAMMING WATER HARDNESS

PROGRAMMING WATER HARDNESS

The **Descaling needed**  message is displayed after a period of time established according to water hardness. The appliance default is pre-set in manufacturing at "level 4" hardness. The machine can also be programmed according to the hardness of the mains water in the various regions so that the machine needs to be de-scaled less often.

MEASURING WATER HARDNESS

Remove the "Total hardness test" indicator paper (C1) provided from its packaging, attached to the instructions.

Immerse the paper completely in a glass of water for about one second.

Remove the paper from the water and shake lightly. After about a minute, 1, 2, 3, or 4 red squares form, depending on the hardness of the water. Each square corresponds to one level.

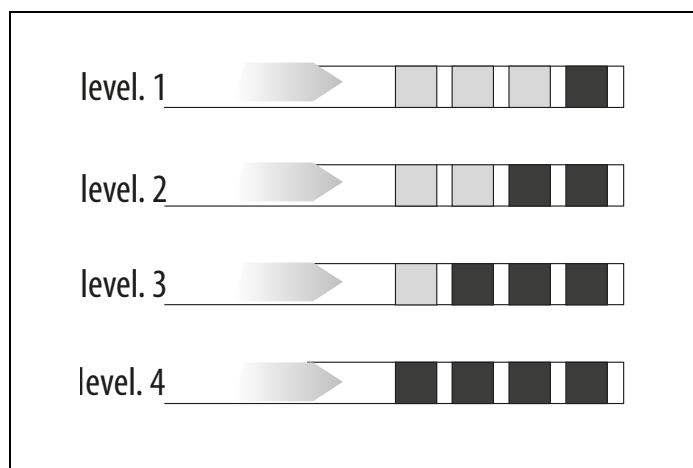

Fig. 59





- 1 Soft water
- 2 Slightly hard water
- 3 Hard water
- 4 Very hard water

SETTING WATER HARDNESS



NOTE

You should customize the water hardness as soon as possible following the instructions in below.

- 1) Press  (B2) to enter the menu;
- 2)  (B10) or  (B8) until the display (B) displays 
Water hardness;
- 3) To change the level selected, press the symbol itself until the required level is displayed (Level 1 = soft water; Level 4 = very hard water);

Press  ESC to go back to the homepage.







The machine is now reprogrammed with the new water hardness setting.

WATER SOFTENER FILTER

Some models are fitted with a water softener filter (C4): if your model is not equipped with one, we recommend buying one through an authorised customer service centre.

To use the filter correctly, follow the instructions below.

INSTALLING THE FILTER

- Remove the filter (C4) from the packaging;
- Press  (B2) to enter the menu;
- Press  (B10) or  (B8) until the display shows  **Water filter**;
- Press ;
- **Turn the date indicator until the next 2 months are displayed** (Fig. 60): turn the date indicator disk until the next two months of use are displayed. Press  NEXT;

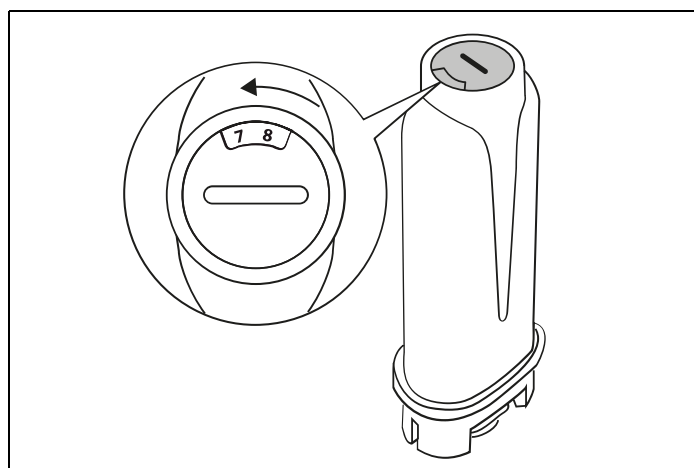



Fig. 60



NOTE

the filter lasts about two months if the appliance is used normally, if the coffee machine is left unused with the filter installed, it will last a maximum of 3 weeks.

- 1) **Fill filter with water until it's completely filled** (Fig. 61): To activate the filter, run tap water through the hole in the filter as shown in the figure until water comes out of the openings at the side for more than a minute. Press  NEXT;

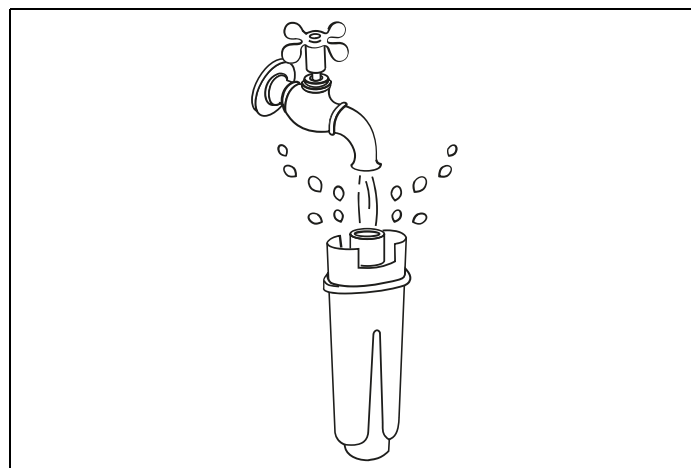



Fig. 61

- 2) Extract the tank (A12) from the appliance and fill with water.
- 3) **Immerse filter in the water tank letting air bubbles escape** (Fig. 62): Insert the filter in the water tank and immerse it completely for about ten seconds, sloping it and pressing it lightly to enable the air bubbles to escape. Press  NEXT;

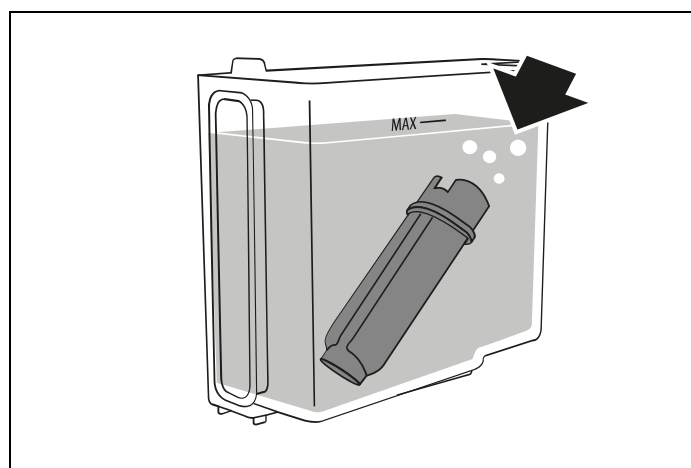







Fig. 62



- 4) **Insert filter into its housing and push it down to the bottom**: Insert the filter in the filter housing (Fig. 58) and press as far as it will go. Press  NEXT;
- 5) **Insert water tank**: Close the tank with the lid (A15), then replace the tank in the machine.
- 6) **Place 0.5l container under outlet Press OK to fill filter** (Fig. 18): place the container under the hot water/steam spout (C6) and press  OK: delivery starts and stops itself automatically.

WATER SOFTENER FILTER







The symbol  appears on the display alongside the time to indicate that the filter has been enabled. The coffee machine can now be used.

REPLACING THE FILTER

Replace the filter **(C4)** when the display **(B)** shows the message **Replace water filter Press OK to start** : to replace immediately, press  and follow the instructions from point 4.

To postpone replacing the filter to another time, press  **ESC**: on the display the symbol  is a reminder that the filter needs to be replaced.

To replace, proceed as follows:

- 1) Extract the water tank **(A12)** and exhausted filter;
- 2) Remove the new filter from the packaging;
- 3) Press  **(B2)** to enter the menu;
- 4) Press  **(B10)** or  **(B8)** until the display shows **Water filter**;
- 5) Press ;
- 6) The display shows  **Replace filter**;
- 7) Press ;
- 8) Follow the operations described in the previous paragraph from point 5.

The filter is now active and the coffee machine can be used.















NOTE

After two months (see date indicator) or when the appliance has not been used for 3 weeks, you should replace the filter even if the message has not yet been displayed.

REMOVING THE FILTER



If you want to use the appliance without the filter **(C4)**, you must remove it and notify the appliance of its removal. Proceed as follows:

- 1) Extract the water tank **(A12)** and exhausted filter;
- 2) Press  **(B2)** to enter the menu;
- 3) Press  **(B10)** or  **(B8)** until the display shows  **Water filter**;
- 4) Press ;
- 5) On the display  **Remove filter** appears;
- 6) Press ;
- 7)  **Remove filter?:** press  **OK** (or to go back to the settings menu, press  **ESC**);
- 8)  **Filter removed:** the appliance has recognised the change. Press  **OK** to go back to the homepage.

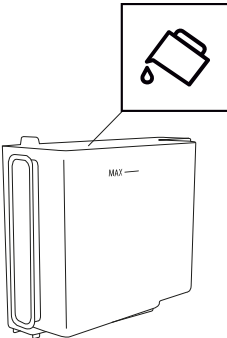
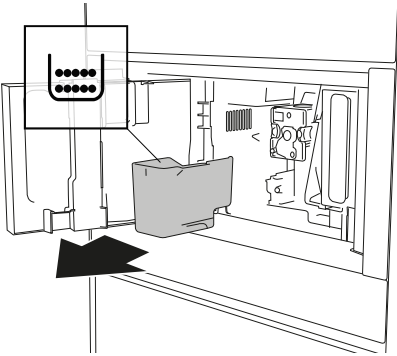
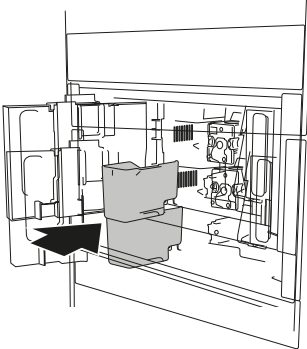
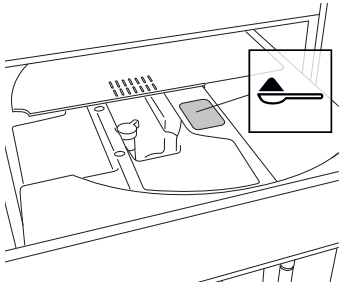
DISPLAYED MESSAGES

	DISPLAYED MESSAGE	POSSIBLE CAUSE	REMEDY
	<p>Fill water tank with fresh water</p>	<p>Water in the tank (A12) is not sufficient.</p>	<p>Fill the tank with water and/or insert it correctly, pushing it as far as it will go until it clicks into place.</p>
	<p>Empty grounds container</p>	<p>The grounds container (A4) is full.</p>	<p>Empty the grounds container and drip tray (A14), clean and then replace them. Important: when removing the drip tray, the grounds container must always be emptied, even if it contains few grounds. If this is not done, when you make the next coffees, the grounds container may fill up more than expected and clog the machine.</p>
	<p>Insert ground container</p>	<p>After cleaning, the grounds container (A4), has not been replaced.</p>	<p>Remove the drip tray (A14) and insert the grounds container</p>
 <p>↳ ESC</p>	<p>Add pre-ground coffee maximum one measuring cup</p>	<p>The "pre-ground coffee" function has been selected, but without placing any pre-ground coffee in the funnel (A21).</p> <p>The funnel (A21) for pre-ground coffee, is clogged</p>	<p>Place pre-ground coffee in the funnel (Fig. 26) and repeat delivery</p> <p>Empty the funnel with the help of the brush (C5) as described in par. <i>Cleaning the pre-ground coffee funnel.</i></p>

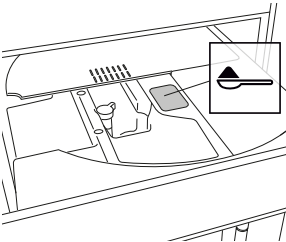
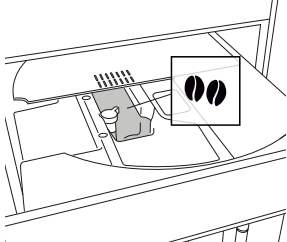
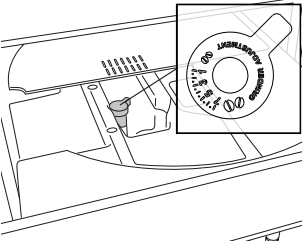

DISPLAYED MESSAGES

	DISPLAYED MESSAGE	POSSIBLE CAUSE	REMEDY
 <p>✓ OK</p>	<p>Add pre-ground coffee maximum one measuring cup</p>	<p>A “LONG” coffee with pre-ground coffee has been requested</p>	<p>Place pre-ground coffee in the funnel (A21) (Fig. 26) and press ✓ OK to continue and complete delivery.</p>
 <p>↳ ESC</p>	<p>Fill bean container</p>	<p>The coffee beans have run out.</p>	<p>Fill the beans container (A16 - Fig. 24).</p>
 <p>↳ ESC</p>	<p>Ground too fine. Adjust grind level 1 level while in operation</p>	<p>The grinding is too fine and the coffee is delivered too slowly or not at all.</p>	<p>Repeat coffee delivery and turn the grinding adjustment dial (Fig. 27) one click clockwise towards number 7 while the coffee mill is in operation. If after making at least 2 coffees delivery is still too slow, repeat the correction procedure, turning the grinding adjustment dial another click (par. <i>Adjusting the coffee mill</i>). If the problem persists, make sure the water tank (A12) is fully inserted.</p>
 <p>↳ ESC</p>	<p>Select a milder taste or reduce pre-ground coffee quantity</p>	<p>If the water softener filter (C4) is present, an air bubble may have been released inside the circuit, obstructing delivery.</p>	<p>Insert the hot water/steam spout (C6) in the appliance and deliver a little water until the flow becomes regular.</p>
 <p>↳ ESC</p>	<p>Select a milder taste or reduce pre-ground coffee quantity</p>	<p>Too much coffee has been used.</p>	<p>Select a milder taste by pressing ☉ Aroma (B6) or reduce the quantity of pre-ground coffee (maximum 1 measure).</p>

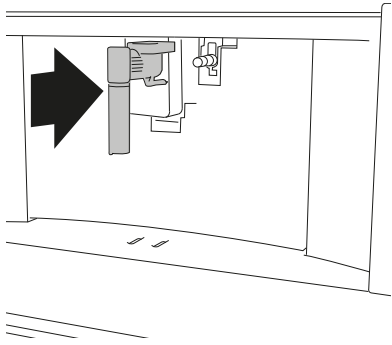
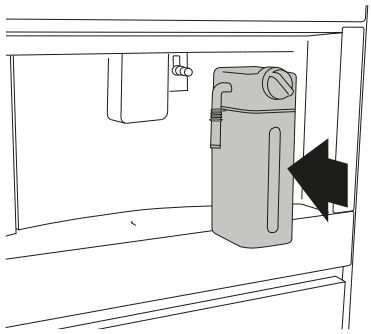
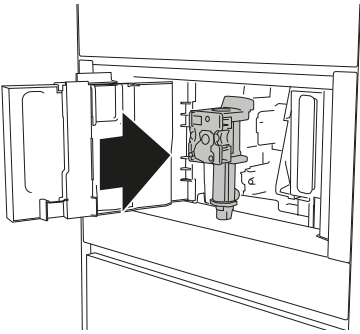
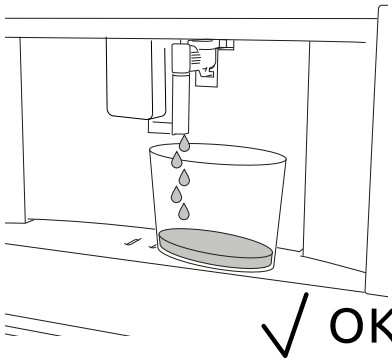



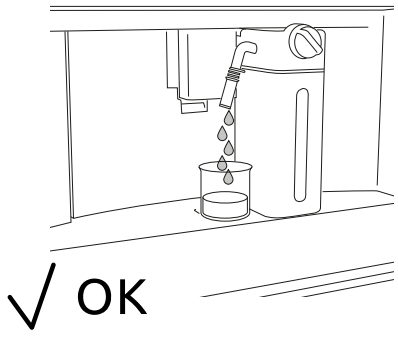
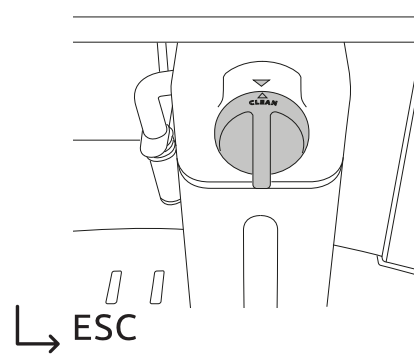
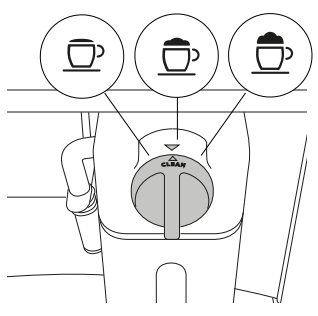

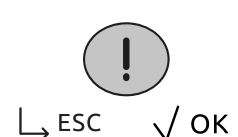

DISPLAYED MESSAGES

	DISPLAYED MESSAGE	POSSIBLE CAUSE	REMEDY
	Insert water outlet	The hot water spout (C6) is not inserted or is inserted incorrectly.	Insert the water spout as far as it will go.
	Insert milk container	The milk container (D) is not inserted correctly.	Insert the milk container as far as it will go (Fig. 34).
	Insert brewing unit	After cleaning the infuser (A5) has not been replaced.	Insert the infuser as described in par. <i>Cleaning the infuser.</i>
	Water circuit empty. Press OK to start filling process	The water circuit is empty	Press \checkmark OK and allow water to drain out of the spout (C6): the flow will stop itself automatically. If the problem persists, make sure the water tank (A12) is fully inserted.

DISPLAYED MESSAGES

	DISPLAYED MESSAGE	POSSIBLE CAUSE	REMEDY
	<p>Press OK to start cleaning process or turn milk froth adjustment knob</p>	<p>The milk container has been inserted with the froth adjustment dial (D1) in the "CLEAN" position .</p>	<p>To proceed with the "CLEAN" function, pressor turn the froth adjustment dial to one of the milk positions.</p>
	<p>Turn milk froth adjustment knob to <CLEAN> to start cleaning</p>	<p>Milk has been delivered recently and the tubes inside the milk container must be cleaned (D).</p>	<p>Turn the froth adjustment dial (D1) to "CLEAN" (Fig. 37).</p>
	<p>Turn the milk froth adjustment knob to milk position</p>	<p>The milk container has been inserted with the froth adjustment dial (D1) in the "CLEAN" position</p>	<p>Turn the dial to the required froth position.</p>
	<p>Descaling needed. Press OK to start (~45min)</p>	<p>Indicates that the machine must be de-scaled.</p>	<p>Press \checkmark OK to start de-scaling or press \hookrightarrow ESC to de-scale later. The de-scaling procedure described in section DESCALING needs to be performed.</p>
	<p>Replace water filter. Press OK to start</p>	<p>The water softener filter (C4) is exhausted.</p>	<p>Press \checkmark OK to replace or remove the filter, or \hookrightarrow ESC to carry out the procedure later. Follow the instructions in section WATER SOFTENER FILTER.</p>

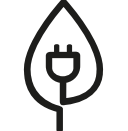
DISPLAYED MESSAGES

	DISPLAYED MESSAGE	POSSIBLE CAUSE	REMEDY
	General alarm: refer to user manual	The inside of the appliance is very dirty.	Clean the inside of the appliance thoroughly, as described in section <i>CLEANING</i> . If the message is still displayed after cleaning, contact an authorised Customer Service centre.
	General alarm: refer to user manual	Reminder that appliance needs de-scaling and/or the filter (C4) must be replaced.	The de-scaling procedure described in section <i>DESCALING</i> needs to be performed as soon as possible and/or the filter needs replacing or removing as described in section <i>WATER SOFTENER FILTER</i> .
	General alarm: refer to user manual	Reminder that tubes inside the milk container (D) must be cleaned.	Turn the froth adjustment dial (D1) to "CLEAN" (Fig. 37).
	General alarm: refer to user manual	Reminder that filter (C4) must be replaced.	Replace the filter or remove it as described in section <i>WATER SOFTENER FILTER</i> .
	General alarm: refer to user manual	Reminder that machine must be de-scaled.	The de-scaling procedure described in section <i>DESCALING</i> needs to be carried out as soon as possible.
	General alarm: refer to user manual	Indicates that the auto-start function is enabled.	To disable the function, proceed as described in par. <i>Auto-start</i> .
	General alarm: refer to user manual	Energy saving is enabled	To disable energy saving, proceed as described in par. <i>Energy saving</i> .
	General alarm: refer to user manual	Indicates that the filter (C4) has been enabled	To remove the filter, proceed as described in section <i>WATER SOFTENER FILTER</i> .

TROUBLESHOOTING

PROBLEM	POSSIBLE CAUSE	REMEDY
The coffee is not hot.	The cups were not preheated.	Warm the cups by rinsing them with hot water.
		 NOTE The hot water function can be used.
	The infuser has cooled down because 2/3 minutes have elapsed since the last coffee was made.	Before making the coffee, heat the infuser by rinsing using the rinse function (see par. <i>RINSING</i>).
	A low coffee temperature is set.	Set a hotter coffee temperature in the menu (see par. <i>Coffee temperature</i>).
The coffee is weak or not creamy enough.	The coffee is ground too coarsely.	Turn the grinding adjustment dial one click anticlockwise towards number 1 while the coffee mill is in operation (Fig. 27). Continue one click at a time until coffee delivery is satisfactory. The effect can only be noticed after delivering 2 coffees (see par. <i>Adjusting the coffee mill</i>).
	The coffee is unsuitable.	Use coffee for espresso machines.
The coffee is delivered too slowly or a drop at a time.	The coffee is ground too finely.	Turn the grinding adjustment dial one click clockwise towards number 7 while the coffee mill is in operation (Fig. 27). Continue one click at a time until coffee delivery is satisfactory. The effect can only be noticed after delivering 2 coffees (see par. <i>Adjusting the coffee mill</i>).
Coffee does not come out of one or both of the spouts.	The coffee spouts (A13) are blocked.	Clean the spouts with a toothpick (Fig. 47).
The appliance is not producing coffee	The appliance detects impurities in its system: the display shows Cleaning .	Wait for the appliance to be ready for use again and reselect the required beverage. Contact an Authorised Customer Service Centre if the problem persists.
The appliance does not come on	It is not plugged into the socket.	Plug into the mains socket (Fig. 15).
	The main switch (A21) is not turned on.	Press the main switch (Fig. 16).
The infuser cannot be extracted	The appliance has not been turned off correctly	Turn the appliance off by pressing the  button (A19) (see section <i>TURNING THE APPLIANCE OFF</i>).
At the end of de-scaling, the appliance requests a third rinse	During the two rinse cycles, the water tank (A12) was not filled to the MAX level	Follow the instructions displayed by the appliance, first emptying the drip tray (A14) to avoid the water overflowing.
The milk does not come out of the milk spout (D5)	The lid (D2) of the milk container (D) is dirty	Clean the milk container lid as described in par. <i>Cleaning the milk container (D)</i> .

TROUBLESHOOTING

PROBLEM	POSSIBLE CAUSE	REMEDY
The milk contains large bubbles and squirts out of the milk spout (D5) or there is little froth	The milk is not cold enough or is not semi-skimmed or skimmed.	Use fully skimmed or semi-skimmed milk at refrigerator temperature (about 5°C). If the result is not as you wished, try changing brand of milk.
	The froth adjustment dial (D1) is incorrectly adjusted.	Adjust following the instructions in section <i>Adjusting the amount of froth</i> .
	The milk container lid (D2) or froth adjustment dial (D1) is dirty	Clean the milk container lid and froth adjustment dial as described in par. <i>Cleaning the milk container (D)</i> .
	The hot water/steam connection nozzle (A13) is dirty.	Clean the connection nozzle as described in par. <i>Cleaning the hot water/steam spout after use</i> .
The machine emits noises or small puffs of steam while not in use	The machine is ready for use, or has recently been turned off, and condensate is dripping into the vaporiser which is still hot.	This is part of normal operation. To limit this, empty the drip tray.

TROUBLESHOOTING AND REPAIRS

In the event of problems, follow the information given in the sections *Displayed messages* and *Troubleshooting*. If this does not resolve the problem, you should consult customer services. For repairs, contact Customer Services Technical Assistance.

WARRANTY AND SERVICE



Bertazzoni is committed to providing the highest quality service to our customers. In the unlikely event that your product should have a manufacturing defect, please contact our service team at:

<https://uk.bertazzoni.com/more/care-service>

You will be requested to provide product information, proof of purchase, a photo of the silver data label and a description of the issue. Please have this information ready.



www.bertazzoni.com
Via Palazzina, 8
42016 Guastalla RE

© 2024 BERTAZZONI. All rights reserved.

CM45MOD2WTB_v.03